

INSTALLATION INSTRUCTIONS

Air Conditioner

Panasonic®

This air conditioner uses the refrigerant R32 or R410A.

Model No.

Indoor Units		Rated Capacity					
Type	Indoor Units Type	15	22	28	36	45	56
M1	Slim Low Static Ducted	S-15MM1E5B	S-22MM1E5B	S-28MM1E5B	S-36MM1E5B	S-45MM1E5B	S-56MM1E5B



ENGLISH

Read through the Installation Instructions before you proceed with the installation.
In particular, you will need to read under the "IMPORTANT!" section at the top of the page.

IMPORTANT! Please Read Before Starting

This air conditioner must be installed by the sales dealer or installer.
This information is provided for use only by authorized persons.

For safe installation and trouble-free operation, you must:

- This Installation Instructions is for the indoor unit and read the Installation Instructions of the outdoor unit as well.
- Carefully read this instruction booklet before beginning.
- Follow each installation or repair step exactly as shown.
- This air conditioner shall be installed in accordance with National Wiring Regulations.
- That compliance with national gas regulations shall be observed.
- The product meets the technical requirements of EN/IEC 61000-3-3.
- Pay close attention to all warning and caution notices given in this manual.



WARNING

- Do not use means to accelerate the defrosting process or to clean, other than those recommended by the manufacturer.
- The appliance shall be stored in a room without continuously operating ignition sources (for example: open flames, an operating gas appliance or an operating electric heater).
- Auxiliary devices which may be a **potential ignition source** shall not be installed in the duct work. Examples of such **potential ignition sources** are hot surfaces with a temperature exceeding 700°C and electric switching devices.
- For appliances connected via an air duct system to one or more rooms, only auxiliary devices approved by the appliance manufacturer or declared suitable with the refrigerant shall be installed in connecting ductwork.
- Do not pierce or burn.
- Be aware that refrigerants may not contain an odour.
- The following checks shall be applied to installations using flammable refrigerants.
Appliance shall be installed, operated and stored in a room with a floor area larger than [Amin] m².
As for [Amin], see Section "Check of Density Limit".



WARNING

This symbol refers to a hazard or unsafe practice which can result in severe personal injury or death.



CAUTION

This symbol refers to a hazard or unsafe practice which can result in personal injury or product or property damage.

If Necessary, Get Help

These instructions are all you need for most installation sites and maintenance conditions. If you require help for a special problem, contact our sales/service outlet or your certified dealer for additional instructions.

In Case of Improper Installation

The manufacturer shall in no way be responsible for improper installation or maintenance service, including failure to follow the instructions in this document.

SPECIAL PRECAUTIONS



WARNING When Wiring



ELECTRICAL SHOCK CAN CAUSE SEVERE PERSONAL INJURY OR DEATH. ONLY A QUALIFIED, EXPERIENCED ELECTRICIAN SHOULD ATTEMPT TO WIRE THIS SYSTEM.

- Do not supply power to the unit until all wiring and tubing are completed or reconnected and checked.

- Highly dangerous electrical voltages are used in this system. Carefully refer to the wiring diagram and these instructions when wiring. Improper connections and inadequate grounding can cause **accidental injury or death**.
- Connect all wiring tightly. Loose wiring may cause overheating at connection points and a possible fire hazard.
- Provide a power outlet to be used exclusively for each unit.
- Provide a power outlet exclusively for each unit, and full disconnection means having a contact separation by 3 mm in all poles must be incorporated in the fixed wiring in accordance with the wiring rules.
- To prevent possible hazards from insulation failure, the unit must be grounded. 
- Check that cabling will not be subject to wear, corrosion, excessive pressure, vibration, sharp edges or any other adverse environmental effects.
The check shall also take into account the effects of aging or continual vibration from sources such as compressors or fans.
- This equipment is strongly recommended to be installed with Earth Leakage Circuit Breaker (ELCB) or Residual Current Device (RCD). Otherwise, it may cause electrical shock and fire in case of equipment breakdown or insulation breakdown.

When Transporting

- It may need two or more people to carry out the installation work.
- Be careful when picking up and moving the indoor and outdoor units. Get a partner to help, and bend your knees when lifting to reduce strain on your back. Sharp edges or thin aluminum fins on the air conditioner can cut your fingers.

When Storing...

WARNING

- The appliance shall be stored in a well-ventilated area where the room size corresponds to the room area as specified for operation.
- The appliance shall be stored in a room without continuously operating open flames (for example: an operating gas appliance) and ignition sources (for example: an operating electric heater).
- The appliance shall be stored so as to prevent mechanical damage from occurring.

When Installing...

- Select an installation location which is rigid and strong enough to support or hold the unit, and select a location for easy maintenance.
- In cases that require mechanical ventilation, ventilation openings shall be kept clear of obstruction.
- An unventilated area where the appliance using flammable refrigerants is installed shall be so constructed that should any refrigerant leak, it will not stagnate so as to create a fire or explosion hazard.
- Ducts connected to an appliance shall not contain a **potential ignition source**;
- Make sure to install protective guards on the suction and discharge side to prevent somebody from touching the fan motor, fan blades or heat exchanger.

...In a Room

Properly insulate any tubing run inside a room to prevent “sweating” that can cause dripping and water damage to walls and floors.



CAUTION Keep the fire alarm and the air outlet at least 1.5 m away from the unit.

...In Moist or Uneven Locations

Use a raised concrete pad or concrete blocks to provide a solid, level foundation for the outdoor unit. This prevents water damage and abnormal vibration.

...In an Area with High Winds

Securely anchor the outdoor unit down with bolts and a metal frame. Provide a suitable air baffle.

...In a Snowy Area (for Heat Pump-type Systems)

Install the outdoor unit on a raised platform that is higher than drifting snow. Provide snow vents.

...At least 1.8 m

Installation height for indoor unit shall be at least 1.8 m.

However, choose the lowest among the following locations.

- Air inlet side of indoor unit
- Air outlet side of indoor unit
- Air inlet port in the room
- Air outlet port in the room

...In laundry rooms

Do not install in laundry rooms. Indoor unit is not drip proof.

When Connecting Refrigerant Tubing

Pay particular attention to refrigerant leakages.



WARNING

- When performing piping work, do not mix air except for specified refrigerant in refrigeration cycle. It causes capacity down, and risk of explosion and injury due to high tension inside the refrigerant cycle.
- If the refrigerant comes in contact with a flame, it produces a toxic gas and a fire.
- Do not add or replace refrigerant other than specified type. It may cause product damage, burst and injury, etc.
- Ventilate the room immediately in the event of a refrigerant gas leakage during installation. Be careful not to allow contact of the refrigerant gas with a flame as this will cause the generation of toxic gas and fire.
- Keep all tubing runs as short as possible.
- Apply refrigerant lubricant to the matching surfaces of the flare and union tubes before connecting them, then tighten the nut with a torque wrench for a leak-free connection.
- Check carefully for leaks before starting the test run.
- Do not leak refrigerant while piping work for an installation or re-installation, and while repairing refrigeration parts.
Handle liquid refrigerant carefully as it may cause frostbite.
- Under no circumstances shall potential sources of ignition be used in the searching or detection of refrigerant leaks.
- A halide torch (or any other detector using a naked flame) shall not be used.

- Electronic leak detectors may be used to detect refrigerant leaks but, the sensitivity may not be adequate, or may need re-calibration. (Detection equipment shall be calibrated in a refrigerant-free area.)
- Ensure that the detector is not a potential source of ignition and is suitable for the refrigerant used.
- Leak detection equipment shall be set at a percentage of the lower flammable limit (LFL) of the refrigerant and shall be calibrated to the refrigerant employed and the appropriate percentage of gas (25% maximum) is confirmed.
- Leak detection fluids are suitable for use with most refrigerants but the use of detergents containing chlorine shall be avoided as the chlorine may react with the refrigerant and corrode the copper pipe-work.
- If a leak is suspected, all naked flames shall be removed/extinguished.
- If a leakage of refrigerant is found which requires brazing, all of the refrigerant shall be recovered from the system, or isolated (by means of shut off valves) in a part of the system remote from the leak. Oxygen free nitrogen (OFN) shall then be purged through the system both before and during the brazing process.
- If refrigerant R32 is used and the optional “R32 refrigerant leakage detection sensor” is connected to the indoor unit, do not turn off the ELCB of the indoor unit except when there is a symptom of abnormality or failure, or when performing short-term maintenance. (When the ELCB is turned off, R32 refrigerant leakage detection sensor cannot detect the refrigerant leakage when the refrigerant leaks, and it may lead to cause the generation of toxic gas and fire.)

When Servicing

- Contact the sales dealer or service dealer for a repair.
- Ventilate the room by opening windows before servicing if there is a possibility of a refrigerant leakage.
- Be sure to turn off the power before servicing.
- Turn the power OFF at the main power box (mains), wait at least 5 minutes until it is discharged, then open the unit to check or repair electrical parts and wiring. 
- Keep your fingers and clothing away from any moving parts.
- Clean up the site after you finish, remembering to check that no metal scraps or bits of wiring have been left inside the unit.

WARNING

- This product must not be modified or disassembled under any circumstances. Modified or disassembled unit may cause fire, electric shock or injury.
- Do not clean inside the indoor and outdoor units by users. Engage authorized dealer or specialist for cleaning.
- In case of malfunction of this appliance, do not repair by yourself. Contact the sales dealer or service dealer for a repair and disposal.

 **CAUTION**

- Ventilate any enclosed areas when installing or testing the refrigeration system. Leaked refrigerant gas, on contact with fire or heat, can produce dangerously toxic gas.
- Confirm after installation that no refrigerant gas is leaking. If the gas comes in contact with a burning stove, gas water heater, electric room heater or other heat source, it can cause the generation toxic gas and fire.

Others

When disposal of the product, do follow the precautions referring to Section “Recovery” in the installation instructions supplied with the outdoor unit and comply with national regulations.

 **WARNING**

- Do not sit or step on the unit. You may fall down accidentally.



 **CAUTION**

- Do not touch the air inlet or the sharp aluminum fins of the outdoor unit. You may get injured.
- Do not stick any object into the FAN CASE. You may be injured and the unit may be damaged.
- Do not touch the fan because it automatically rotates when it detects a refrigerant leak. You may be injured.



SERVICING

CAUTION

- Any qualified person who is involved with working on or breaking into a refrigerant circuit should hold a current valid certificate from an industry-accredited assessment authority, which authorizes their competence to handle refrigerants safely in accordance with an industry recognised assessment specification.
 - Servicing shall only be performed as recommended by the equipment manufacturer. Maintenance and repair requiring the assistance of other skilled personnel shall be carried out under the supervision of the person competent in the use of flammable refrigerants.
 - Servicing shall be performed only as recommended by the manufacturer.
 - Prior to beginning work on systems containing flammable refrigerants, safety checks are necessary to ensure that the risk of ignition is minimised. For repair to the refrigerating system, (2) to (6) shall be completed prior to conducting work on the system.
- (1) Work shall be undertaken under a controlled procedure so as to minimise the risk of a flammable gas or vapour being present while the work is being performed.
 - (2) All maintenance staff and others working in the local area shall be instructed on the nature of work being carried out. Work in confined spaces shall be avoided. The area around the workspace shall be sectioned off. Ensure that the conditions within the area have been made safe by control of flammable material.
 - (3) The area shall be checked with an appropriate refrigerant detector prior to and during work, to ensure the technician is aware of potentially toxic or flammable atmospheres. Ensure that the leak detection equipment being used is suitable for use with all applicable refrigerants, i.e. non-sparking, adequately sealed or intrinsically safe.
 - (4) If any hot work is to be conducted on the refrigerating equipment or any associated parts, appropriate fire extinguishing equipment shall be available to hand. Have a dry powder or CO₂ fire extinguisher adjacent to the charging area.
 - (5) No person carrying out work in relation to a refrigerating system which involves exposing any pipe work shall use any sources of ignition in such a manner that it may lead to the risk of fire or explosion. All possible ignition sources, including cigarette smoking, should be kept sufficiently far away from the site of installation, repairing, removing and disposal, during which refrigerant can possibly be released to the surrounding space. Prior to work taking place, the area around the equipment is to be surveyed to make sure that there are no flammable hazards or ignition risks. "No Smoking" signs shall be displayed.
 - (6) Ensure that the area is in the open or that it is adequately ventilated before breaking into the system or conducting any hot work. A degree of ventilation shall continue during the period that the work is carried out. The ventilation should safely disperse any released refrigerant and preferably expel it externally into the atmosphere.
 - (7) Where electrical components are being changed, they shall be fit for the purpose and to the correct specification. At all times the manufacturer's maintenance and service guidelines shall be followed. If in doubt, consult the manufacturer's technical department for assistance.
 - The actual refrigerant charge is in accordance with the room size within which the refrigerant containing parts are installed.
 - The ventilation machinery and outlets are operating adequately and are not obstructed.

- Marking to the equipment continues to be visible and legible. Markings and signs that are illegible shall be corrected.
 - Refrigerating pipe or components are installed in a position where they are unlikely to be exposed to any substance which may corrode refrigerant containing components, unless the components are constructed of materials which are inherently resistant to being corroded or are suitably protected against being so corroded.
- (8) Repair and maintenance to electrical components shall include initial safety checks and component inspection procedures. If a fault exists that could compromise safety, then no electrical supply shall be connected to the circuit until it is satisfactorily dealt with. If the fault cannot be corrected immediately but it is necessary to continue operation, an adequate temporary solution shall be used. This shall be reported to the owner of the equipment so all parties are advised. Initial safety checks shall include:
- That capacitors are discharged. This shall be done in a safe manner to avoid possibility of sparking.
 - That no live electrical components and wiring are exposed while charging, recovering or purging the system.
 - That there is continuity of earth bonding.
- During repairs to sealed components, all electrical supplies shall be disconnected from the equipment being worked upon prior to any removal of sealed covers, etc.
 - Particular attention shall be paid to the following to ensure that by working on electrical components, the casing is not altered in such a way that the level of protection is affected. This shall include damage to cables, excessive number of connections, terminals not made to original specification, damage to seals, incorrect fitting of glands, etc.
 - Ensure that apparatus is mounted securely.
 - Ensure that seals or sealing materials have not degraded such that they no longer serve the purpose of preventing the ingress of flammable atmospheres.
 - Replacement parts shall be in accordance with the manufacturer's specifications.

NOTE:

The use of silicon sealant may inhibit the effectiveness of some types of leak detection equipment. Intrinsically safe components do not have to be isolated prior to working on them.

- Do not apply any permanent inductive or capacitance loads to the circuit without ensuring that this will not exceed the permissible voltage and current permitted for the equipment in use.
- Intrinsically safe components are the only types that can be worked on while live in the presence of a flammable atmosphere.
- The test apparatus shall be at the correct rating.
- Replace components only with parts specified by the manufacturer. Unspecified parts by manufacturer may result ignition of refrigerant in the atmosphere from a leak.

REMOVAL AND EVACUATION

CAUTION

- When breaking into the refrigerant circuit to make repairs – or for any other purpose – conventional procedures shall be used. However, it is important that best practice is followed since flammability is a consideration.
The following procedure shall be adhered to:
 - Remove refrigerant.
 - Purge the circuit with inert gas.
 - Evacuate.
 - Purge again with inert gas.
 - Open the circuit by cutting or brazing.
- The refrigerant charge shall be recovered into the correct recovery cylinders.
- The system shall be “flushed” with Oxygen free nitrogen (OFN) to render the unit safe.
- This process may need to be repeated several times.
- Compressed air or oxygen shall not be used for this task.
- Flushing shall be achieved by breaking the vacuum in the system with OFN and continuing to fill until the working pressure is achieved, then venting to atmosphere, and finally pulling down to a vacuum.
- This process shall be repeated until no refrigerant is within the system.
- When the final OFN charge is used, the system shall be vented down to atmospheric pressure to enable work to take place.
- This operation is absolutely vital if brazing operations on the pipe work are to take place.
- Ensure that the outlet for the vacuum pump is not close to any potential ignition sources and there is ventilation available.

CHARGING PROCEDURES

NOTE:

Refer to the Installation Instructions attached to the outdoor unit.

DECOMMISSIONING

CAUTION

- Before carrying out this procedure, it is essential that the technician is completely familiar with the equipment and all its details.
- It is recommended good practice that all refrigerants are recovered safely.
- Prior to the task being carried out, an oil and refrigerant sample shall be taken in case analysis is required prior to re-use of recovered refrigerant.
- It is essential that electrical power is available before the task is commenced.
 - a) Become familiar with the equipment and its operation.
 - b) Isolate system electrically.
 - c) Before attempting the procedure ensure that:
 - Mechanical handling equipment is available, if required, for handling refrigerant cylinders.
 - All personal protective equipment is available and being used correctly.
 - The recovery process is supervised at all times by a competent person.

- Recovery equipment and cylinders conform to the appropriate standards.
- d) Pump down refrigerant system, if possible.
- e) If a vacuum is not possible, make a manifold so that refrigerant can be removed from various parts of the system.
- f) Make sure that cylinder is situated on the scales before recovery takes place.
- g) Start the recovery machine and operate in accordance with instructions.
- h) Do not overfill cylinders. (No more than 80% volume liquid charge).
- i) Do not exceed the maximum working pressure of the cylinder, even temporarily.
- j) When the cylinders have been filled correctly and the process completed, make sure that the cylinders and the equipment are removed from site promptly and all isolation valves on the equipment are closed off.
- k) Recovered refrigerant shall not be charged into another refrigerating system unless it has been cleaned and checked.
- Electrostatic charge may accumulate and create a hazardous condition when charging or discharging the refrigerant.
To avoid fire or explosion, dissipate static electricity during transfer by grounding and bonding containers and equipment before charging / discharging.

RECOVERY

NOTE:

Refer to the Installation Instructions attached to the outdoor unit.

NOTICE

The English text is the original instructions. Other languages are translations of the original instructions.

Check of Density Limit

Check the amount of refrigerant in the system and floor space of the room according to the legislation on refrigerant drainage. If there is no applicable legislation, follow the standards described below.

The refrigerant (R32), which is used in the air conditioner, is a flammable refrigerant. So the requirements for the maximum refrigerant charge amount $[m_{max}]$ used in the appliance are determined according to installation space of the appliance.

Installation conditions

Procedure of preliminary calculation

1. Determine the room space in accordance with the requirements of installation.
2. Calculate the maximum refrigerant charge amount $[m_{max}]$.

When connecting the refrigerant tubes and installing the indoor unit in each partitioned room, it is necessary to calculate the allowable refrigerant charge amount in each room.

For all indoor units shown in Fig. 1, calculate the allowable refrigerant charge amount that can be used in each room $[m_{IN_1}, m_{IN_2}, \dots, m_{IN_n}]$.

Calculate the maximum refrigerant charge for each indoor unit from Fig. 2 by referring to the following items.

- Floor area of the room
- Indoor units type
- Capacity of indoor unit
- Installation height of Indoor Unit
- Use or nonuse of R32 refrigerant leakage detection sensor

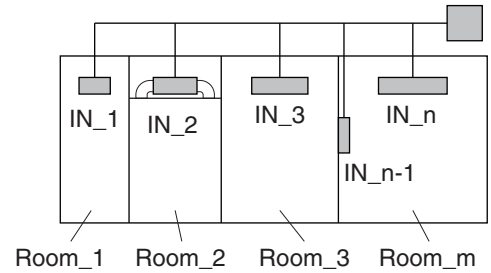

Fig. 1

Room No.	No. of indoor units	Indoor units type	Capacity of indoor unit	Installation height of Indoor Unit: h_{inst} (m)	R32 refrigerant leakage detection sensor	Floor area of the room (m ²)	Refrigerant charge amount that can be used for each indoor unit (kg)
Room_1	IN_1	4-Way Cassette 60 × 60	15	$h_{inst} \geq 2.2$	Use	10	m_{IN_1}
Room_2	IN_2	Slim Low Static Ducted	56	$h_{inst} \geq 2.2$	Nonuse	15	m_{IN_2}
Room_3	IN_3	4-Way Cassette	56	$h_{inst} \geq 2.2$	Use	20	m_{IN_3}
---	---	---	---	---	---	---	---
Room_m	IN_{n-1}	Wall-Mounted	45	$h_{inst} \geq 1.8$	Nonuse	30	$m_{IN_{n-1}}$
Room_m	IN_n	4-Way Cassette	140	$h_{inst} \geq 2.2$	Use	30	m_{IN_n}

$$[m_{max}] = \text{Min} (m_{IN_1}, m_{IN_2}, m_{IN_3}, \dots, m_{IN_{n-1}}, m_{IN_n})$$

The minimum value of the allowable refrigerant charge amount in each room is the maximum value of the maximum refrigerant charge amount $[m_{max}]$ that can be used in the system.

3. Calculate the maximum refrigerant charge amount $[m_c]$ by following details of piping installation.

As a reference, refer to Installation Instructions of outdoor unit.

4. Determine from two values $[m_{max}]$ in Step 2 and $[m_c]$ in Step 3.

$[m_c] \leq [m_{max}]$: Can be installed.

$[m_c] > [m_{max}]$: Return to Steps 1 to 3 and change the indoor unit type, capacity and pipe length.

< Whether or not to use R32 refrigerant leakage detection sensor >

- According to the type of diagrams shown in Fig. 2, it is necessary to install R32 refrigerant leakage detection sensor if the installation space is within the range of using R32 refrigerant leakage detection sensor.
- As to installation method of R32 refrigerant leakage detection sensor, refer to the Installation Instructions attached to the indoor unit and R32 refrigerant leakage detection sensor.
- When connecting R32 refrigerant leakage detection sensor, group connection with a remote controller is not possible. Be sure to prepare a remote controller for each indoor unit.

The refrigerant charge amount compared with the floor area of the room is roughly as follows:

NOTE

In the case of connecting R32 refrigerant leakage detection sensor :

- For systems using R32 refrigerant, this unit is equipped with a refrigerant leak detector for safety. To be effective, the unit must be electrically powered at all times after installation, other than when servicing.

Fig. 2

Slim Low Static Ducted

When connecting the duct to either inlet side or outlet side

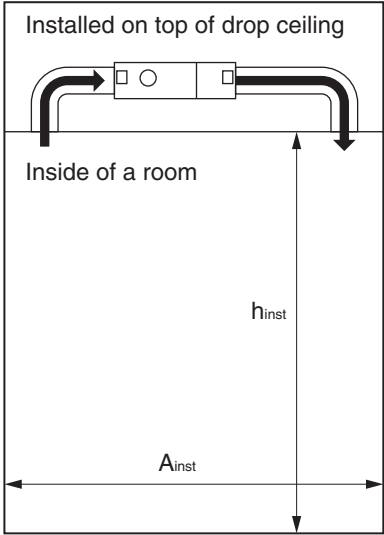

A_{inst} : Floor area of the room (m^2)

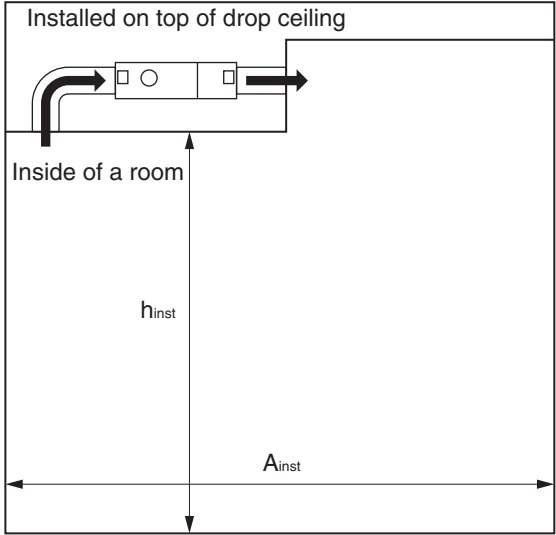

When not partitioning : Calculate from A_{inst} and h_{inst}

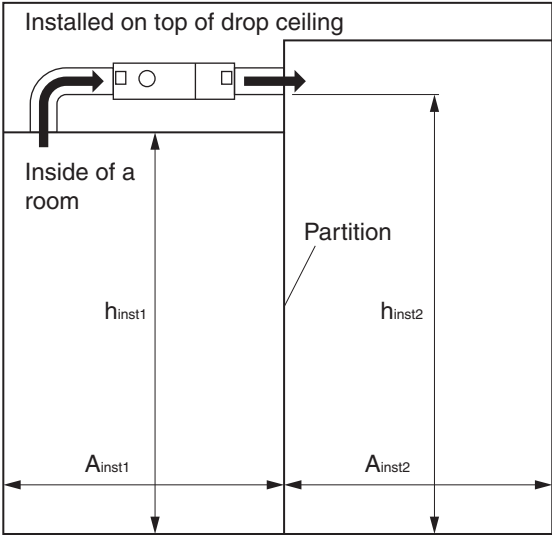

When partitioning : Calculate from A_{inst1} and h_{inst1} , and calculate from A_{inst2} and h_{inst2} respectively.

Type 15, 22, 28, 36, 45, 56

$h_{inst} \geq 2.2$

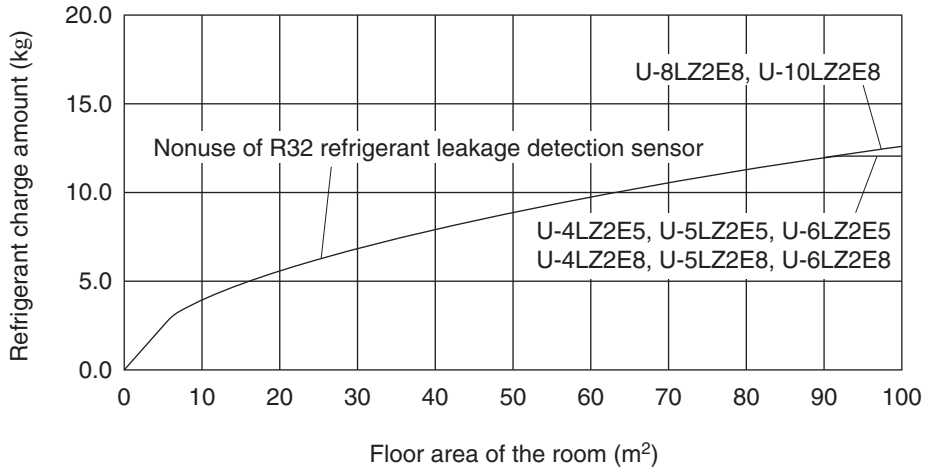

$1.8 \leq h_{inst} < 2.2$

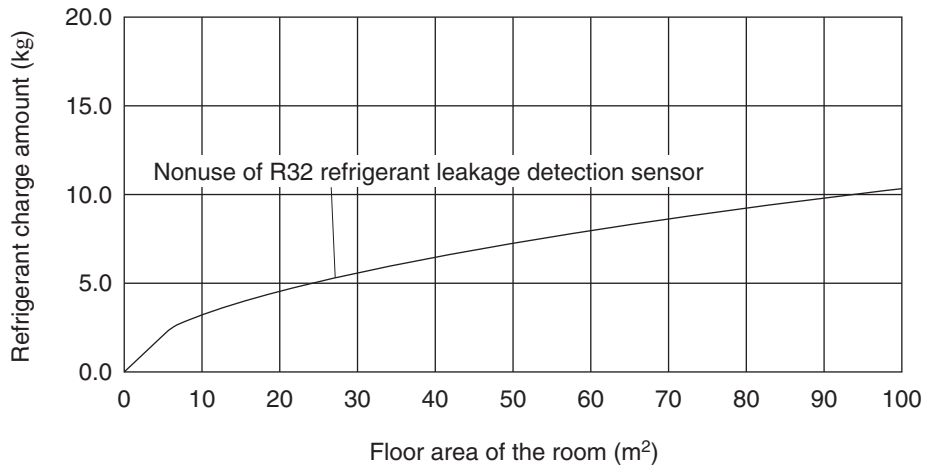

Slim Low Static Ducted			
Concealed Ceiling			
When connecting the duct to either inlet side or outlet side			
		$h_{inst} \geq 2.2$	$1.8 \leq h_{inst} < 2.2$
	Use or nonuse of R32 refrigerant leakage detection sensor	Nonuse	Nonuse
	Capacity of indoor unit	15~56	15~56
		Refrigerant charge amount (kg)	
Floor area of the room (m ²)	0	0.0	0.0
	2	1.0	0.8
	4	2.0	1.6
	6	3.0	2.4
	8	3.5	2.9
	10	3.9	3.2
	12	4.3	3.5
	14	4.7	3.8
	16	5.0	4.1
	18	5.3	4.3
	20	5.6	4.5
	22	5.8	4.8
	24	6.1	5.0
	26	6.4	5.2
	28	6.6	5.4
	30	6.8	5.6
	32	7.1	5.8
	34	7.3	5.9
	36	7.5	6.1
	38	7.7	6.3
	40	7.9	6.5
	42	8.1	6.6
	44	8.3	6.8
	46	8.5	6.9
	48	8.7	7.1
	50	8.8	7.2
	52	9.0	7.4
	54	9.2	7.5
56	9.4	7.6	
58	9.5	7.8	
60	9.7	7.9	
62	9.8	8.0	
64	10.0	8.2	
66	10.2	8.3	
68	10.3	8.4	
70	10.5	8.6	

Slim Low Static Ducted			
Concealed Ceiling			
When connecting the duct to either inlet side or outlet side			
		$h_{inst} \geq 2.2$	$1.8 \leq h_{inst} < 2.2$
	Use or nonuse of R32 refrigerant leakage detection sensor	Nonuse	Nonuse
	Capacity of indoor unit	15~56	15~56
		Refrigerant charge amount (kg)	
Floor area of the room (m ²)	72	10.6	8.7
	74	10.8	8.8
	76	10.9	8.9
	78	11.1	9.0
	80	11.2	9.1
	82	11.3	9.3
	84	11.5	9.4
	86	11.6	9.5
	88	11.7	9.6
	90	11.9	9.7
	92	12.0	9.8
	94	12.1 (12.0)	9.9
	96	12.3 (12.0)	10.0
98	12.4 (12.0)	10.1	
100	12.5 (12.0)	10.2	

() : U-4LZ2E5, U-5LZ2E5, U-6LZ2E5, U-4LZ2E8, U-5LZ2E8, U-6LZ2E8

Fig. 2

Slim Low Static Ducted

When not connecting the duct to either the inlet side or outlet side

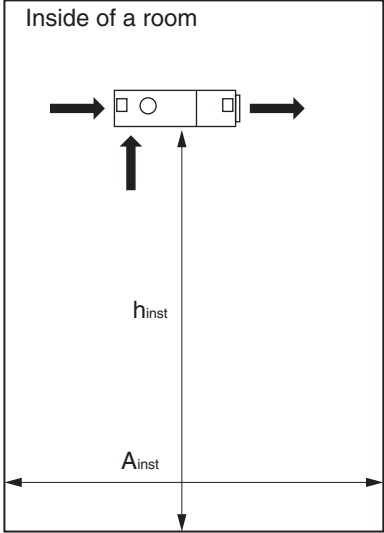

A_{inst} : Floor area of the room (m^2)

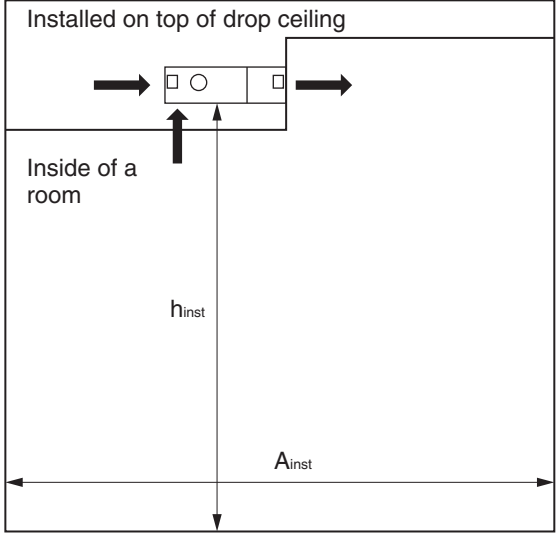

When not partitioning : Calculate from A_{inst} and h_{inst}

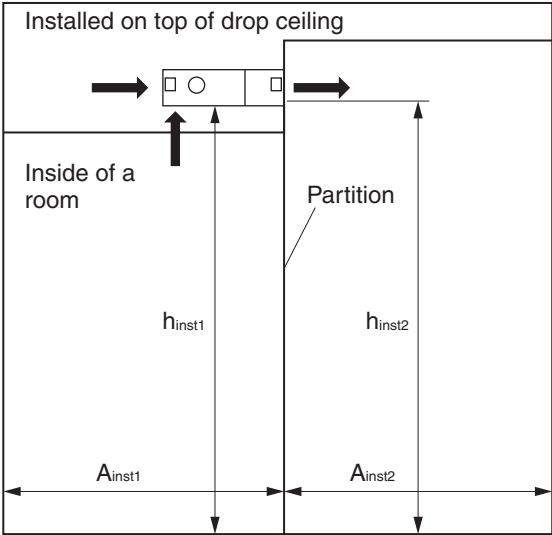

When partitioning : Calculate from A_{inst1} and h_{inst1} , and calculate from A_{inst2} and h_{inst2} respectively.

Type 15, 22

$h_{inst} \geq 2.2$

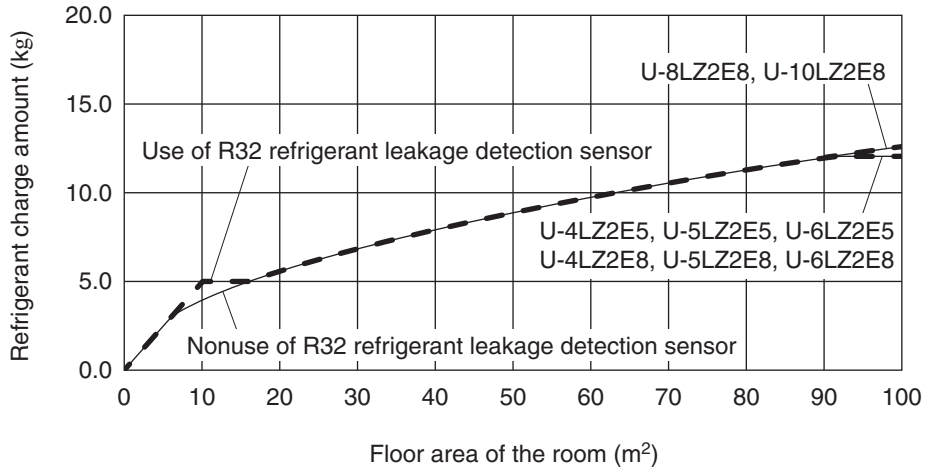

$1.8 \leq h_{inst} < 2.2$

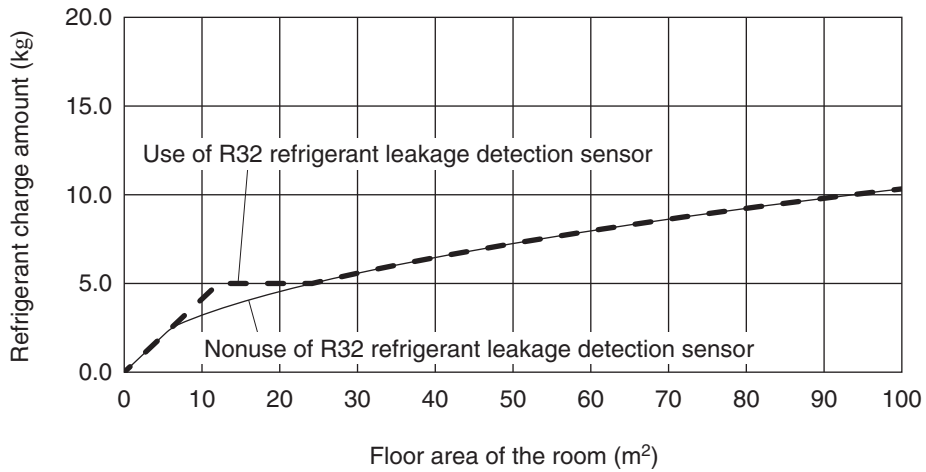

Type 28

$h_{inst} \geq 2.2$

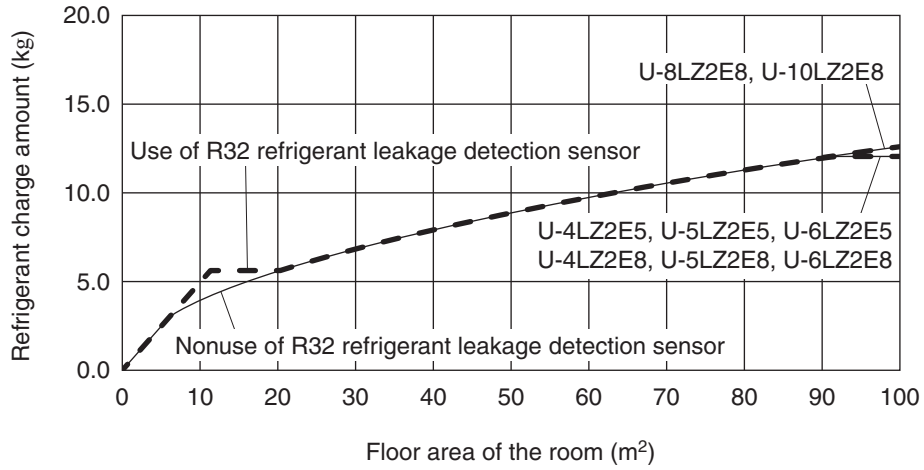

$1.8 \leq h_{inst} < 2.2$

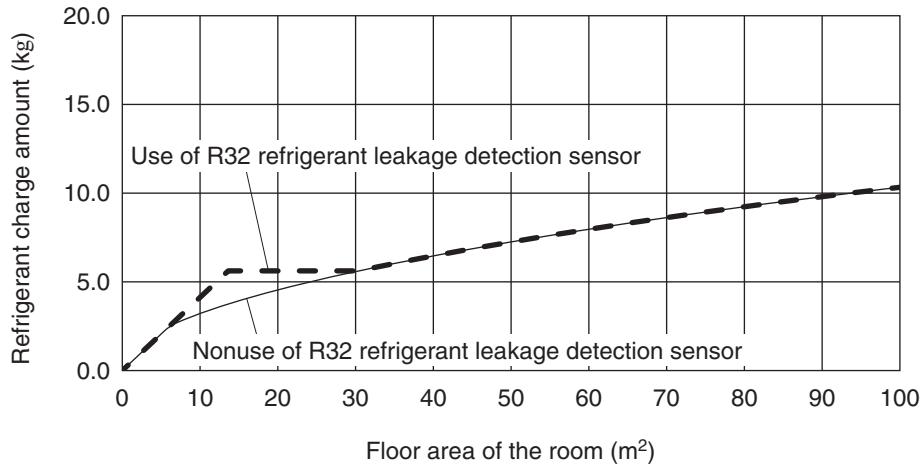

Type 36

$h_{inst} \geq 2.2$

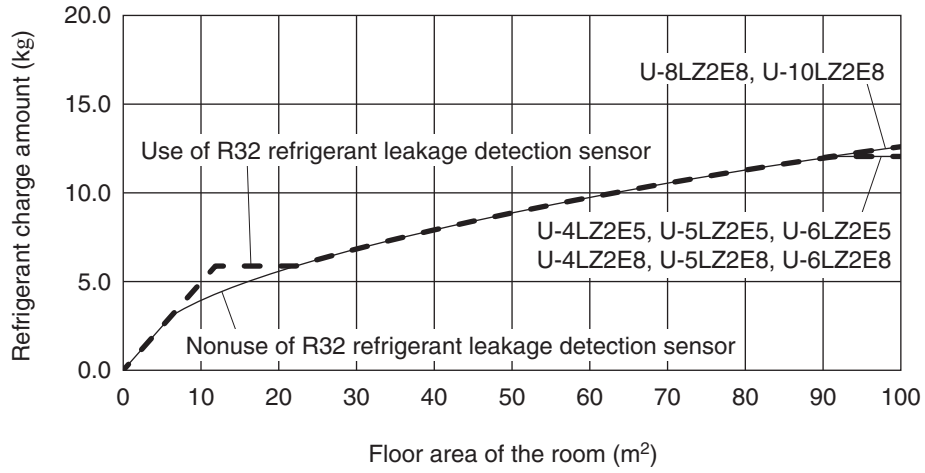

$1.8 \leq h_{inst} < 2.2$

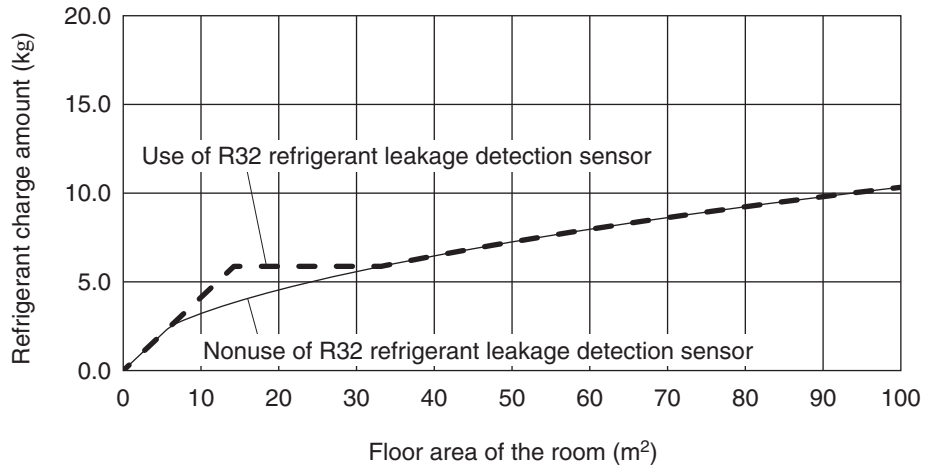

Type 45

$h_{inst} \geq 2.2$

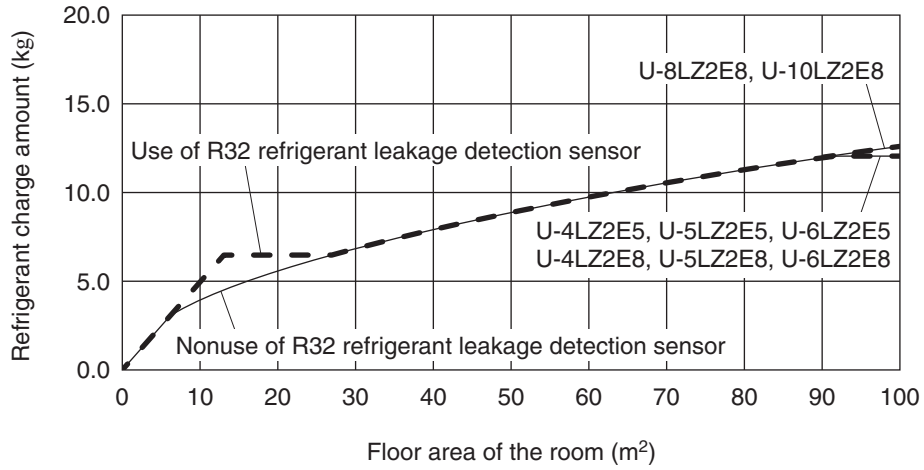

$1.8 \leq h_{inst} < 2.2$

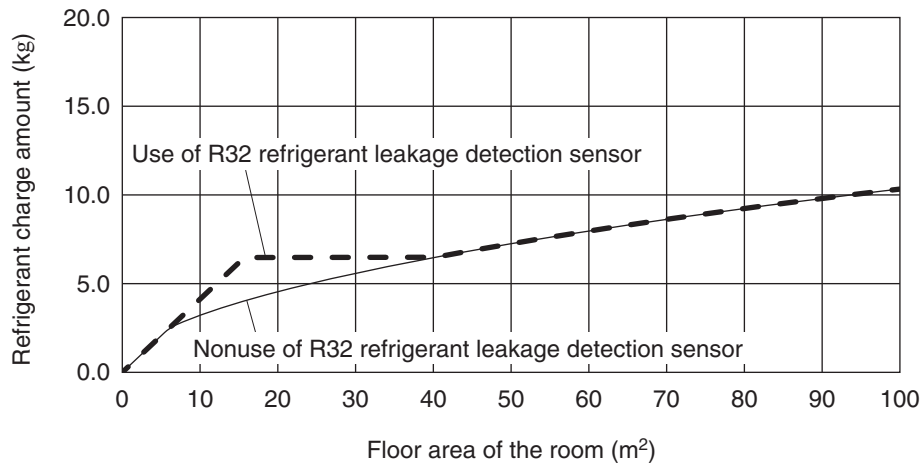

Type 56

$h_{inst} \geq 2.2$

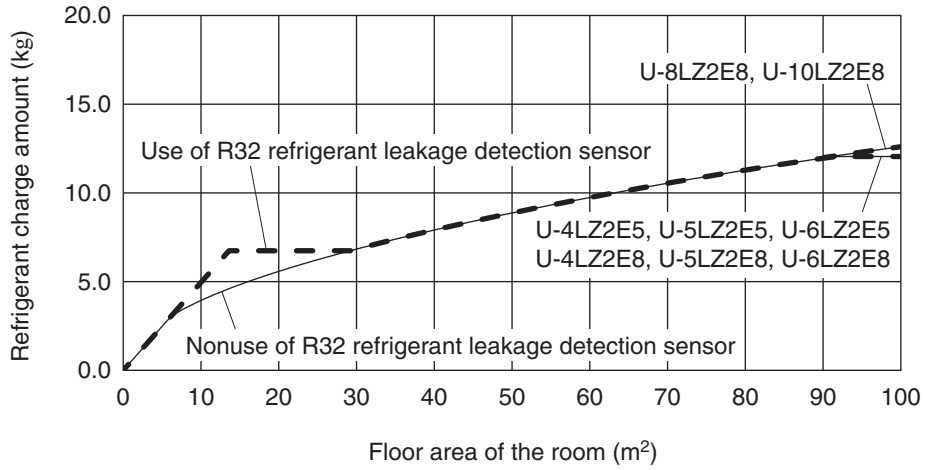

$1.8 \leq h_{inst} < 2.2$

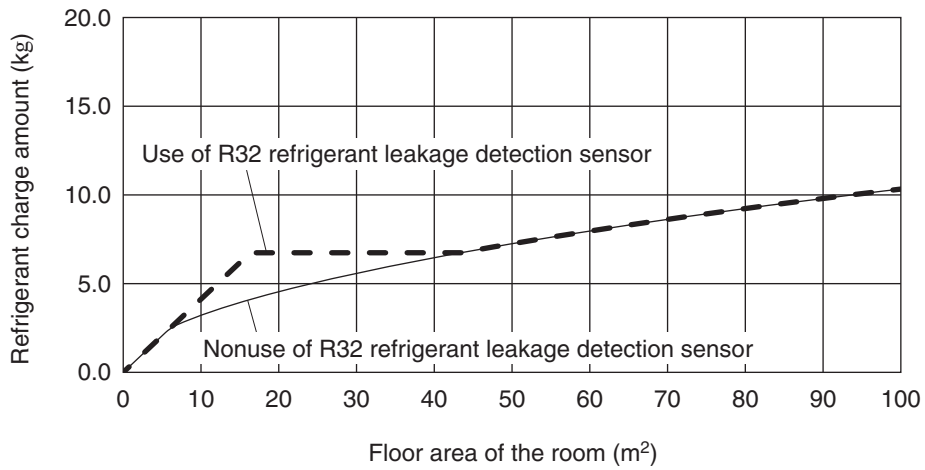

Slim Low Static Ducted													
Concealed Ceiling													
When not connecting the duct to either the inlet side or outlet side													
Use or nonuse of R32 refrigerant leakage detection sensor	$h_{inst} \geq 2.2$						$1.8 \leq h_{inst} < 2.2$						
	Nonuse	Use					Nonuse	Use					
	Capacity of indoor unit	15~56	15, 22	28	36	45	56	15~56	15, 22	28	36	45	56
Refrigerant charge amount (kg)													
0	0.0	0.0	0.0	0.0	0.0	0.0	0.0	0.0	0.0	0.0	0.0	0.0	0.0
2	1.0	1.0	1.0	1.0	1.0	1.0	0.8	0.8	0.8	0.8	0.8	0.8	0.8
4	2.0	2.0	2.0	2.0	2.0	2.0	1.6	1.6	1.6	1.6	1.6	1.6	1.6
6	3.0	3.0	3.0	3.0	3.0	3.0	2.4	2.4	2.4	2.4	2.4	2.4	2.4
8	3.5	4.0	4.0	4.0	4.0	4.0	2.9	3.3	3.3	3.3	3.3	3.3	3.3
10	3.9	5.0	5.0	5.0	5.0	5.0	3.2	4.1	4.1	4.1	4.1	4.1	4.1
12	4.3	5.0	5.6	5.8	6.0	6.0	3.5	4.9	4.9	4.9	4.9	4.9	4.9
14	4.7	5.0	5.6	5.8	6.4	6.6	3.8	5.0	5.6	5.8	5.8	5.8	5.8
16	5.0	5.0	5.6	5.8	6.4	6.6	4.1	5.0	5.6	5.8	6.4	6.6	6.6
18	5.3	5.3	5.6	5.8	6.4	6.6	4.3	5.0	5.6	5.8	6.4	6.6	6.6
20	5.6	5.6	5.6	5.8	6.4	6.6	4.5	5.0	5.6	5.8	6.4	6.6	6.6
22	5.8	5.8	5.8	5.8	6.4	6.6	4.8	5.0	5.6	5.8	6.4	6.6	6.6
24	6.1	6.1	6.1	6.1	6.4	6.6	5.0	5.0	5.6	5.8	6.4	6.6	6.6
26	6.4	6.4	6.4	6.4	6.4	6.6	5.2	5.2	5.6	5.8	6.4	6.6	6.6
28	6.6	6.6	6.6	6.6	6.6	6.6	5.4	5.4	5.6	5.8	6.4	6.6	6.6
30	6.8	6.8	6.8	6.8	6.8	6.8	5.6	5.6	5.6	5.8	6.4	6.6	6.6
32	7.1	7.1	7.1	7.1	7.1	7.1	5.8	5.8	5.8	5.8	6.4	6.6	6.6
34	7.3	7.3	7.3	7.3	7.3	7.3	5.9	5.9	5.9	5.9	6.4	6.6	6.6
36	7.5	7.5	7.5	7.5	7.5	7.5	6.1	6.1	6.1	6.1	6.4	6.6	6.6
38	7.7	7.7	7.7	7.7	7.7	7.7	6.3	6.3	6.3	6.3	6.4	6.6	6.6
40	7.9	7.9	7.9	7.9	7.9	7.9	6.5	6.5	6.5	6.5	6.5	6.5	6.6
42	8.1	8.1	8.1	8.1	8.1	8.1	6.6	6.6	6.6	6.6	6.6	6.6	6.6
44	8.3	8.3	8.3	8.3	8.3	8.3	6.8	6.8	6.8	6.8	6.8	6.8	6.8
46	8.5	8.5	8.5	8.5	8.5	8.5	6.9	6.9	6.9	6.9	6.9	6.9	6.9
48	8.7	8.7	8.7	8.7	8.7	8.7	7.1	7.1	7.1	7.1	7.1	7.1	7.1
50	8.8	8.8	8.8	8.8	8.8	8.8	7.2	7.2	7.2	7.2	7.2	7.2	7.2
52	9.0	9.0	9.0	9.0	9.0	9.0	7.4	7.4	7.4	7.4	7.4	7.4	7.4
54	9.2	9.2	9.2	9.2	9.2	9.2	7.5	7.5	7.5	7.5	7.5	7.5	7.5
56	9.4	9.4	9.4	9.4	9.4	9.4	7.6	7.6	7.6	7.6	7.6	7.6	7.6
58	9.5	9.5	9.5	9.5	9.5	9.5	7.8	7.8	7.8	7.8	7.8	7.8	7.8
60	9.7	9.7	9.7	9.7	9.7	9.7	7.9	7.9	7.9	7.9	7.9	7.9	7.9
62	9.8	9.8	9.8	9.8	9.8	9.8	8.0	8.0	8.0	8.0	8.0	8.0	8.0
64	10.0	10.0	10.0	10.0	10.0	10.0	8.2	8.2	8.2	8.2	8.2	8.2	8.2
66	10.2	10.2	10.2	10.2	10.2	10.2	8.3	8.3	8.3	8.3	8.3	8.3	8.3
68	10.3	10.3	10.3	10.3	10.3	10.3	8.4	8.4	8.4	8.4	8.4	8.4	8.4
70	10.5	10.5	10.5	10.5	10.5	10.5	8.6	8.6	8.6	8.6	8.6	8.6	8.6

Floor area of the room (m²)

Slim Low Static Ducted													
Concealed Ceiling													
When not connecting the duct to either the inlet side or outlet side													
	Use or nonuse of R32 refrigerant leakage detection sensor	$h_{inst} \geq 2.2$						$1.8 \leq h_{inst} < 2.2$					
		Nonuse	Use					Nonuse	Use				
	Capacity of indoor unit	15~56	15, 22	28	36	45	56	15~56	15, 22	28	36	45	56
Refrigerant charge amount (kg)													
Floor area of the room (m ²)	72	10.6	10.6	10.6	10.6	10.6	10.6	8.7	8.7	8.7	8.7	8.7	8.7
	74	10.8	10.8	10.8	10.8	10.8	10.8	8.8	8.8	8.8	8.8	8.8	8.8
	76	10.9	10.9	10.9	10.9	10.9	10.9	8.9	8.9	8.9	8.9	8.9	8.9
	78	11.1	11.1	11.1	11.1	11.1	11.1	9.0	9.0	9.0	9.0	9.0	9.0
	80	11.2	11.2	11.2	11.2	11.2	11.2	9.1	9.1	9.1	9.1	9.1	9.1
	82	11.3	11.3	11.3	11.3	11.3	11.3	9.3	9.3	9.3	9.3	9.3	9.3
	84	11.5	11.5	11.5	11.5	11.5	11.5	9.4	9.4	9.4	9.4	9.4	9.4
	86	11.6	11.6	11.6	11.6	11.6	11.6	9.5	9.5	9.5	9.5	9.5	9.5
	88	11.7	11.7	11.7	11.7	11.7	11.7	9.6	9.6	9.6	9.6	9.6	9.6
	90	11.9	11.9	11.9	11.9	11.9	11.9	9.7	9.7	9.7	9.7	9.7	9.7
	92	12.0	12.0	12.0	12.0	12.0	12.0	9.8	9.8	9.8	9.8	9.8	9.8
	94	12.1 (12.0)	12.1 (12.0)	12.1 (12.0)	12.1 (12.0)	12.1 (12.0)	12.1 (12.0)	9.9	9.9	9.9	9.9	9.9	9.9
	96	12.3 (12.0)	12.3 (12.0)	12.3 (12.0)	12.3 (12.0)	12.3 (12.0)	12.3 (12.0)	10.0	10.0	10.0	10.0	10.0	10.0
98	12.4 (12.0)	12.4 (12.0)	12.4 (12.0)	12.4 (12.0)	12.4 (12.0)	12.4 (12.0)	10.1	10.1	10.1	10.1	10.1	10.1	
100	12.5 (12.0)	12.5 (12.0)	12.5 (12.0)	12.5 (12.0)	12.5 (12.0)	12.5 (12.0)	10.2	10.2	10.2	10.2	10.2	10.2	

() : U-4LZ2E5, U-5LZ2E5, U-6LZ2E5, U-4LZ2E8, U-5LZ2E8, U-6LZ2E8





CONTENTS

	Page		Page
IMPORTANT	2	7. HOW TO INSTALL WIRELESS REMOTE CONTROLLER	48
Please Read Before Starting		NOTE	
Check of Density Limit		Refer to the Installation Instructions attached to the optional Wireless Remote Controller.	
1. GENERAL	26	8. CHECKLIST AFTER INSTALLATION WORK	49
1-1. Tools Required for Installation (not supplied)		9. EXTERNAL STATIC PRESSURE SETTING	50
1-2. Accessories Supplied with Unit		9-1. How to Set on Indoor Unit Control PCB	
1-3. Type of Copper Tube and Insulation Material		9-2. Operating the High-spec Wired Remote Controller (CZ-RTC5B)	
1-4. Additional Materials Required for Installation		9-3. Operating the Timer Remote Controller (CZ-RTC4)	
2. SELECTING THE INSTALLATION SITE	28	9-4. Operating the Wired Remote Controller (CZ-RTC6 series)	
2-1. Indoor Unit		10. APPENDIX	56
3. HOW TO INSTALL THE INDOOR UNIT	30	■ Care and Cleaning	
3-1. Required Minimum Space for Installation and Maintenance Services		■ Troubleshooting	
3-2. Preparations Before Installation		■ Tips for Energy Saving	
3-3. For Bottom Intake		Important Information Regarding The Refrigerant Used	60
3-4. Installing the Duct			
3-5. Suspending the Indoor Unit			
3-6. Installing the Drain Pipe			
3-7. Checking the Drainage			
4. ELECTRICAL WIRING	39		
4-1. General Precautions on Wiring			
4-2. Wire Length and Wire Diameter for Power Supply System			
4-3. Wiring System Diagrams			
5. HOW TO PROCESS TUBING	45		
5-1. Connecting the Refrigerant Tubing			
5-2. Connecting Tubing Between Indoor and Outdoor Units			
5-3. Insulating the Refrigerant Tubing			
5-4. Taping the Tubes			
5-5. Finishing the Installation			
6. HOW TO INSTALL THE TIMER REMOTE CONTROLLER OR HIGH-SPEC WIRED REMOTE CONTROLLER (OPTIONAL PART)	48		
NOTE			
Refer to the Installation Instructions attached to the optional Timer Remote Controller or optional High-spec Wired Remote Controller.			

1. GENERAL

This booklet briefly outlines where and how to install the air conditioning system. Please read over the entire set of instructions for the indoor and outdoor units and make sure all accessory parts listed are with the system before beginning.









The installation of pipe-work shall be kept to a minimum.

 WARNING	This symbol shows that this equipment uses a flammable refrigerant. If the refrigerant is leaked, together with an external ignition source, there is a possibility of ignition.
 CAUTION	This symbol shows that the Operating Instructions should be read carefully.
 CAUTION	This symbol shows that a service personnel should be handling this equipment with reference to the Technical Manual.
 CAUTION	This symbol shows that there is information included in the Operating Instructions and/or Installation Instructions.

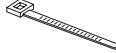
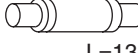
1-1. Tools Required for Installation (not supplied)

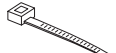
1. Flathead screwdriver
2. Phillips head screwdriver
3. Knife or wire stripper
4. Tape measure
5. Carpenter's level
6. Sabre saw or keyhole saw
7. Hacksaw
8. Core bits
9. Hammer
10. Drill
11. Tube cutter
12. Tube flaring tool
13. Torque wrench
14. Adjustable wrench
15. Reamer (for deburring)

1-2. Accessories Supplied with Unit

Part Name	Figure	Q'ty	Remarks
Washer		8	For suspension fitting
Flare insulator		2	For gas tube / liquid tube connection
Clamper		4	For flare / drain insulating connection
Drain hose	 L=131	1	For unit & PVC pipe connection
Hose band		1	For drain hose connection
Drain insulator		2	For drain pipe connection
Clamper		1	For power supply cord
	Be sure to fix the power supply cord with the clamper.		
Short-circuit connection		1	For high static pressure (Located on the back of the electrical component box lid.)
Operating Instructions		1	
Installation Instructions		1	

- Use M10 for suspension bolts.
- Field supply for suspension bolts and nuts.

1-3. Type of Copper Tube and Insulation Material

If you wish to purchase these materials separately from a local source, you will need:

1. Deoxidized annealed copper tube for refrigerant tubing.
2. Foamed polyethylene insulation for copper tubes as required to precise length of tubing. Wall thickness of the insulation should be not less than 8 mm.
3. Use insulated copper wire for field wiring. Wire size varies with the total length of wiring. See Section "4. ELECTRICAL WIRING" for details.



CAUTION

Check local electrical codes and regulations before obtaining wire. Also, check any specified instructions or limitations.

1-4. Additional Materials Required for Installation

1. Refrigeration (armored) tape
2. Insulated staples or clamps for connecting wire (See your local codes.)
3. Putty
4. Refrigeration tubing lubricant
5. Clamps or saddles to secure refrigerant tubing
6. Scale for weighing

2. SELECTING THE INSTALLATION SITE

2-1. Indoor Unit

AVOID:

- areas where leakage of flammable gas may be expected.
- places where large amounts of oil mist exist.
- direct sunlight.
- locations near heat sources which may affect the performance of the unit.
- locations where external air may enter the room directly. This may cause “condensation” on the air discharge ports, causing them to spray or drip water.
- locations where the remote controller will be splashed with water or affected by dampness or humidity.
- installing the remote controller behind curtains or furniture.
- locations where high-frequency emissions are generated.

DO:

- select an appropriate position from which every corner of the room can be uniformly cooled.
- select a location where the ceiling is strong enough to support the weight of the unit.
- make sure to install protective guards on the suction and discharge side to prevent somebody from touching the fan motor, fan blades or heat exchanger.
- select a location where tubing and drain pipe have the shortest run to the outdoor unit.
- allow room for operation and maintenance as well as unrestricted airflow around the unit.
- the limitation of the tubing length between the indoor and the outdoor units should be referred to the Installation Instructions of the outdoor unit.
- allow room for mounting the remote controller about 1 m off the floor, in an area that is not in direct sunlight or in the flow of cool air from the indoor unit.
- The elevation (Slim Low Static Ducted) between the bottom unit and the floor surface is available in a height of 1.8 m or more.
- In order to avoid touching the electrical parts or fan with hands directly, attach a filter or a protective device (field supply) to the unit.

Slim Low Static Ducted Type

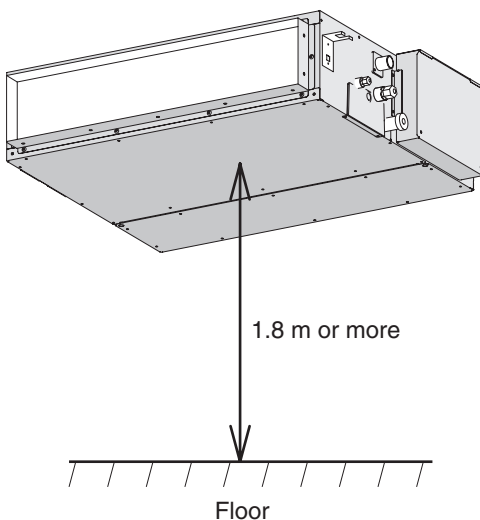

Installation location of R32 refrigerant leakage detection sensor

When installing R32 refrigerant leakage detection sensor away from the indoor unit, place it at 300 mm or less from a floor surface and satisfy the condition either (1) or (2) below.

- (1) If no obstacles exist in a straight line from R32 refrigerant leakage detection sensor to the indoor unit, wall distance should be within 10 m in horizontal straight line.

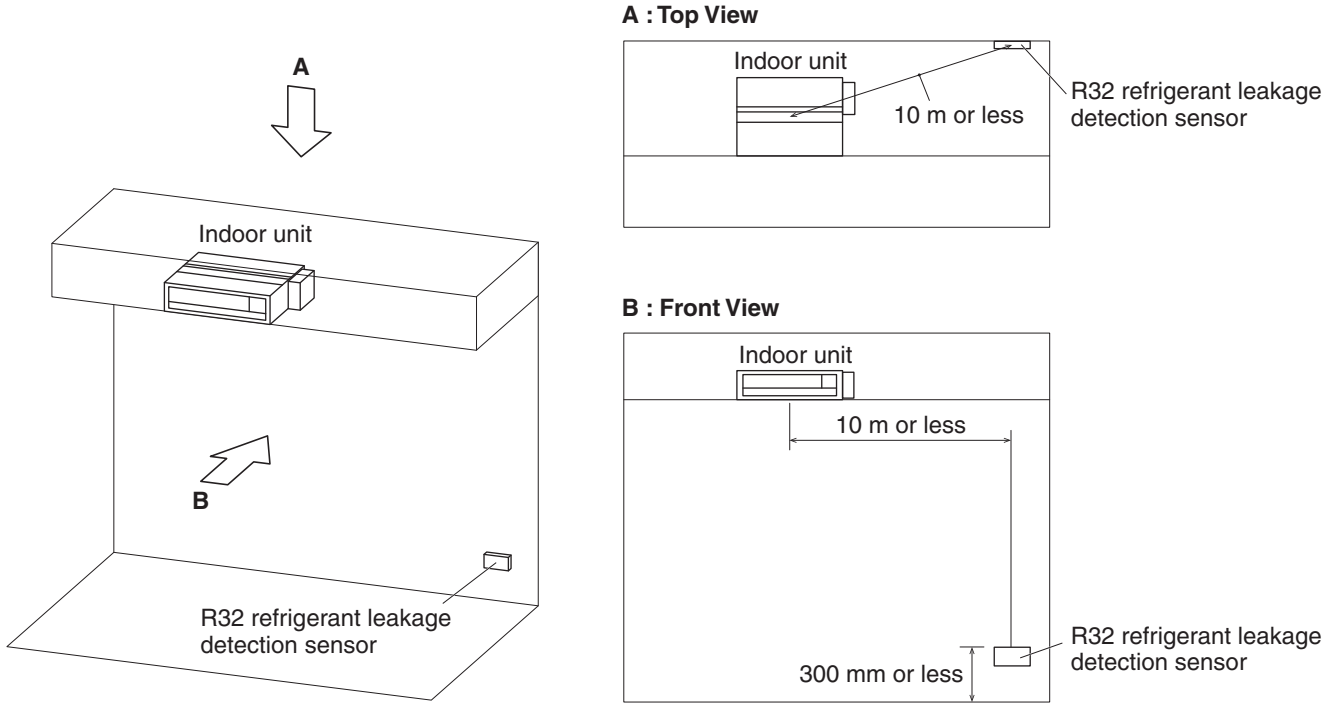

- (2) If obstacles exist in a straight line from R32 refrigerant leakage detection sensor to the indoor unit, wall distance should be within 7 m in horizontal straight line.

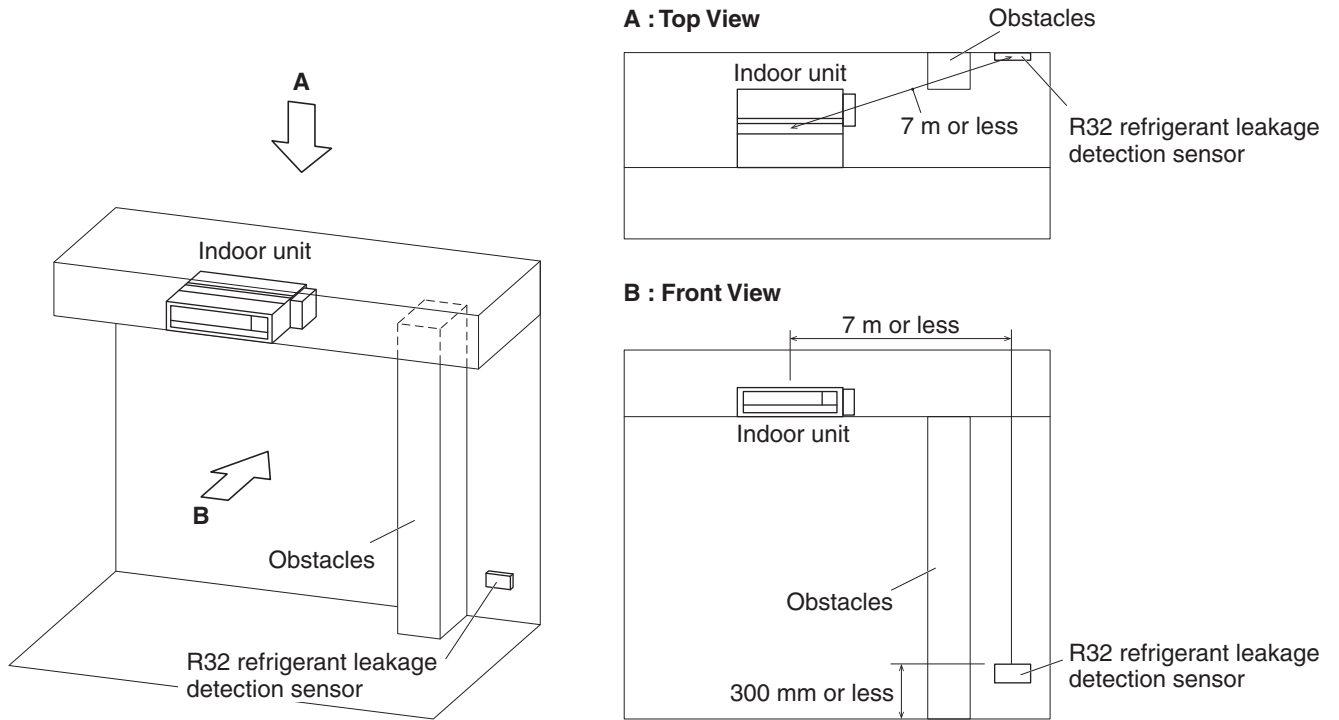

3. HOW TO INSTALL THE INDOOR UNIT

3-1. Required Minimum Space for Installation and Maintenance Services

- This air conditioner is usually installed above the ceiling so that the indoor unit and ducts are not visible. Only the air intake and air outlet ports are visible from below.
- The minimum space for installation and maintenance services is shown in the figure.
- *H dimension means the minimum height of the unit.
- Select the *H dimension such that a downward slope of at least 1/100 is ensured as indicated in “3-6. Installing the Drain Pipe”.

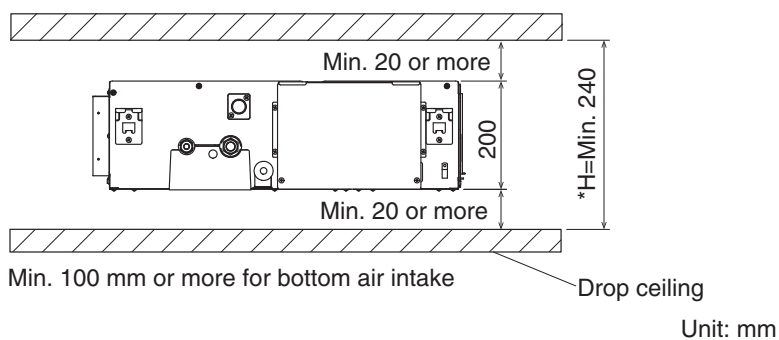
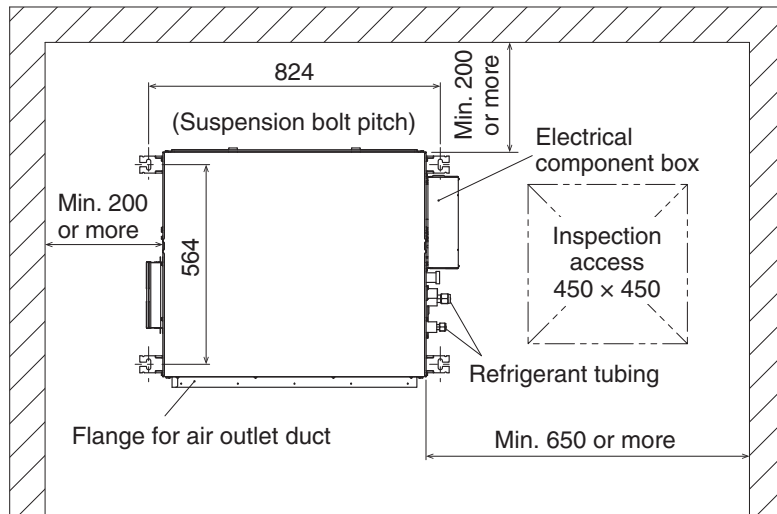

● The diagram shows the detailed dimensions of the indoor unit.

- a) Refrigerant tubing joint (liquid tube)
- b) Refrigerant tubing joint (gas tube)
- c) Upper and bottom drain port (O.D.26 mm)
- d) Suspension lug
- e) Power supply outlet (ø17 mm)
- f) Flange for air outlet duct
- g) Cover plate
- h) Electrical component box
- i) Filter
- j) Inter-unit control wiring and control wiring for group control outlet (ø15 mm)
- k) Remote control wiring outlet (ø15 mm)

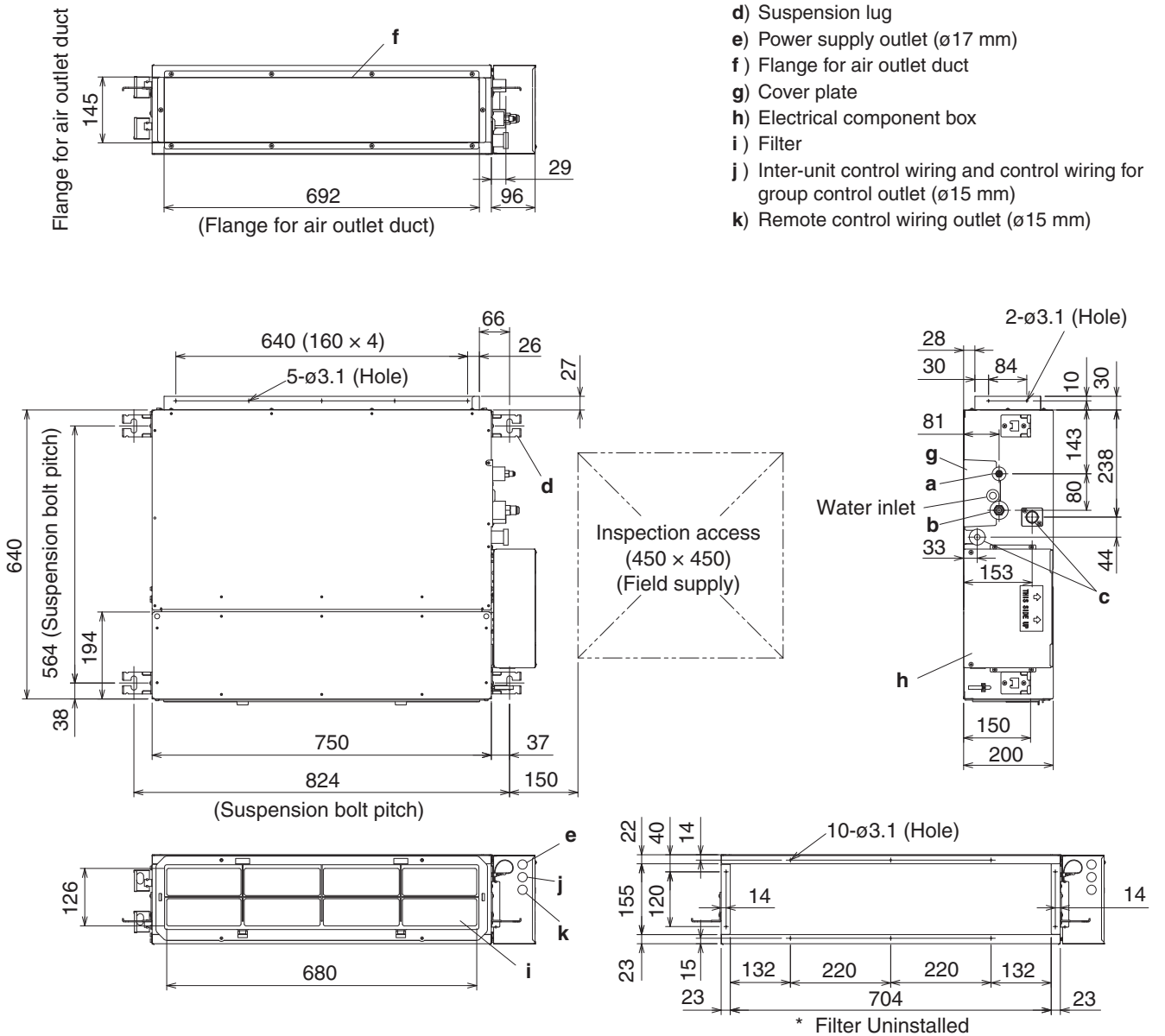

Unit : mm

3-2. Preparation Before Installation

- (1) Confirm the positional relationship between the unit and suspension bolts.
- Install the inspection opening on the control box side where maintenance and inspection of the control box and drain pump are easy. Install the inspection opening also in the lower part of the unit.
- (2) Make sure the range of the unit's external static pressure is not exceeded.
(See the technical documentation for the range of the external static pressure setting.)
- (3) Open the installation hole. (Pre-set ceilings)
- Once the installation hole is opened in the ceiling where the unit is to be installed, pass refrigerant tubing, drain piping, inter-unit control wiring, and remote control wiring to the unit's piping and wiring holes.
See Section "5. HOW TO PROCESS TUBING", "3-6. Installing the Drain Pipe" and "4. ELECTRICAL WIRING".
- After opening the ceiling hole, make sure ceiling is level if needed. It might be necessary to reinforce the ceiling frame to prevent shaking.
Consult an architect or carpenter for details.

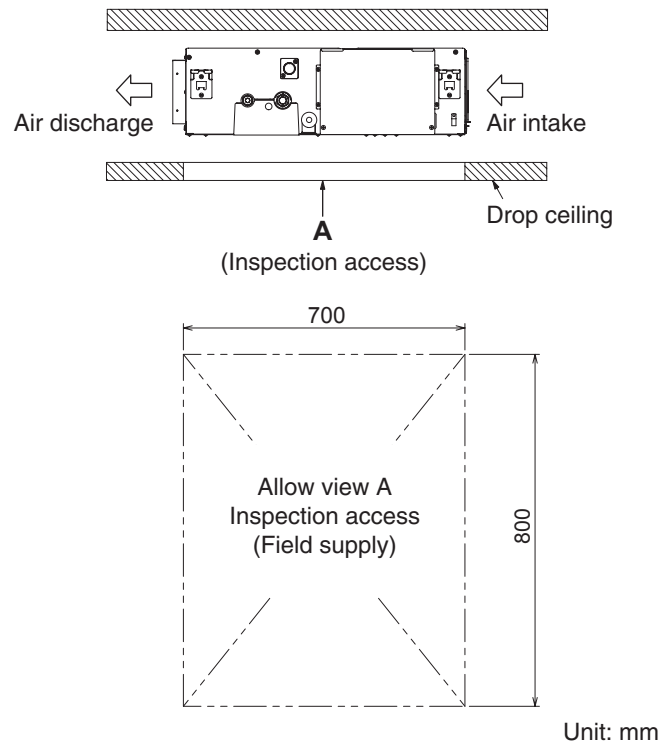

3-3. For Bottom Intake

For bottom intake, replace the cover plate and frame filter assy net in the procedure shown in the diagram.

- (1) Remove the frame filter assy.
Remove the cover plate.

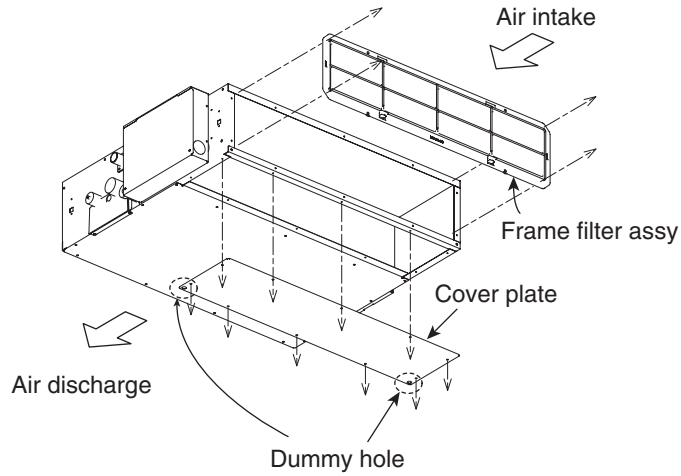

- (2) Refer to the diagram to attach the cover plate and frame filter assy in the direction of the arrow.

Note: Attach the cover plate with the dummy holes downward.

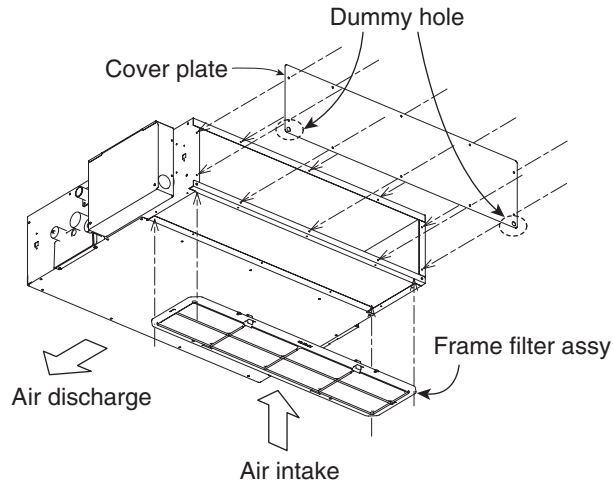

- (3) Attach the frame filter assy (supplied) in the manner shown in the diagram.

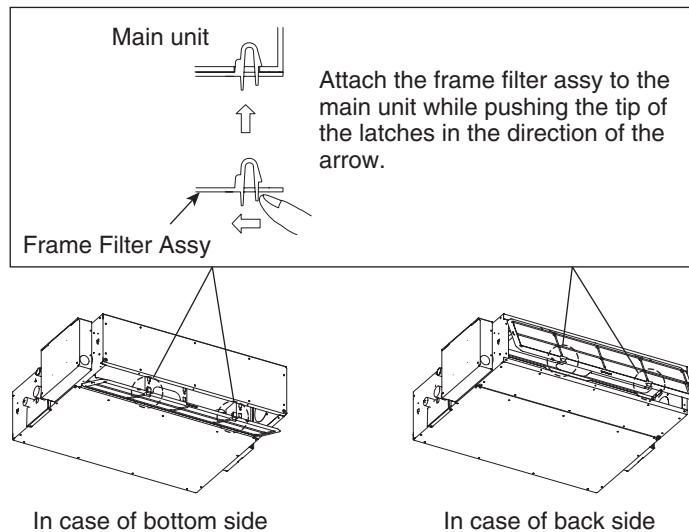

3-4. Installing the Duct

Connecting to the duct in case of connecting to the indoor unit using R32 refrigerant.
Connect the duct supplied in the field as shown in the diagram.

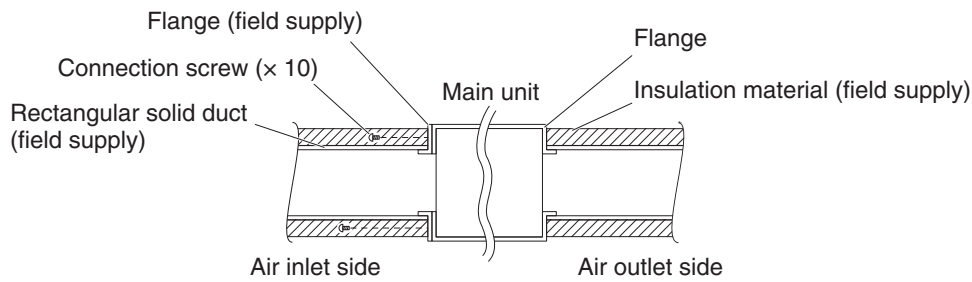

Air inlet side

- Attach the duct and intake-side flange (field supply).
- Connect the flange to the main unit with 10 - $\phi 3.1$ (Hole) screws.
- Wrap the intake-side flange and duct connection area with aluminum tape or something similar to prevent air escaping.



CAUTION

When attaching a duct to the intake side, be sure to attach an air filter inside the air passage on the intake side. (Use an air filter whose dust collecting efficiency is at least 50% in a gravimetric technique.)

The included filter is not used when the intake duct is attached.

Air outlet side

- Connect the duct according to the air outside of the outlet-side flange.
- Wrap the outlet-side flange and the duct connection area with aluminum tape or something similar to prevent air escaping.



CAUTION

- Be sure to insulate the duct to prevent condensation from forming. (Material: glass wool or polyethylene foam, 25 mm thick)
- Use electric insulation between the duct and the wall when using metal ducts to pass metal laths of the net or fence shape or metal plating into wooden buildings.
- Be sure to explain about the way of maintaining and cleaning local procurements (air filter, grille [both air discharge and intake grille], etc.) to your customer.

3-5. Suspending the Indoor Unit

Depending on the ceiling type:

- a) Insert suspension bolts.
- or
- b) Use existing ceiling supports or construct a suitable support.

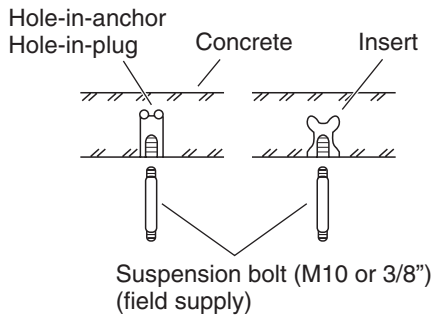

a)

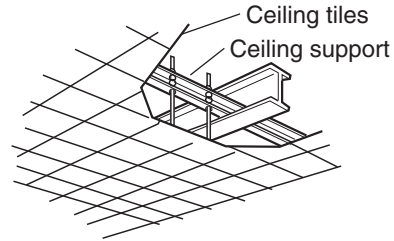

b)

WARNING

It is important that you use extreme care in supporting the indoor unit inside the ceiling. Ensure that the ceiling is strong enough to support the weight of the unit. Before hanging the unit, test the strength of each attached suspension bolt.

- (1) When placing the unit inside the ceiling, determine the pitch of the suspension bolts referring to the dimensional data as shown in the diagrams under Section 3-1. Tubing must be laid and connected inside the ceiling when suspending the unit. If the ceiling is already constructed, lay the tubing into position for connection to the unit before placing the unit inside the ceiling.
- (2) Screw in the suspension bolts allowing them to protrude from the ceiling. (Cut the ceiling material, if necessary.)
- (3) Thread the 3 hexagonal nuts (field supply) and 2 washers (supplied) onto each of the 4 suspension bolts. Use 1 nut and 1 washer for the upper part, and 2 nuts and 1 washer for the lower part, so that the unit will not fall off the suspension lugs.

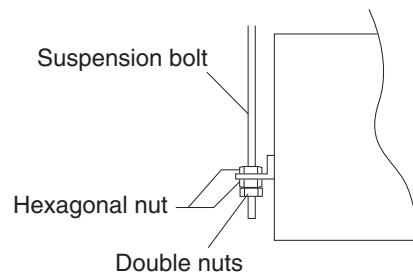
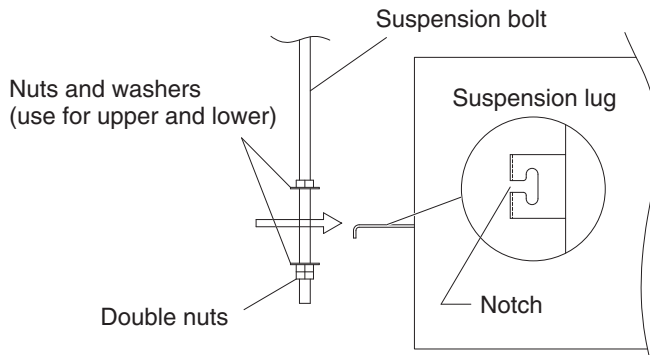

- (4) Adjust the height of the unit.
- (5) Check the unit is horizontally level.

CAUTION

- Make sure the unit is installed level using a level or a vinyl hose filled with water. In using a vinyl hose instead of a level, adjust the top surface of the unit to the surface of the water at both ends of the vinyl hose and adjust the unit horizontally. (One thing to watch out for in particular is if the unit is installed so that the slope is not in the direction of the drain piping, this might cause leaking.)

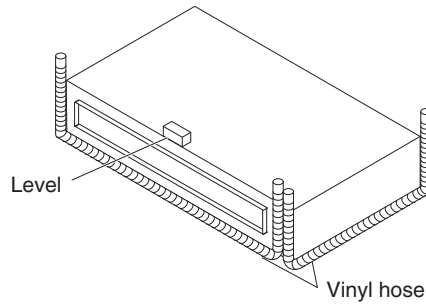

(6) Tighten the upper nut.

3-6. Installing the Drain Pipe

(1) Prepare standard hard PVC pipe (O.D. 26 mm) for the drain and use the supplied hose band to prevent water leaks.

The PVC pipe must be purchased separately.

The transparent drain part on the unit allows you to check drainage.

⚠ CAUTION

- Attach so that the hose band fastener is on the side of the drain port.
- Attach the hose bands so that each is approximately 5 to 25 mm from the end of the supplied drain hose.
- **Do not use adhesive at the drain connection port on the indoor unit.**
- **Insert the drain pipe until it contacts the socket, and then secure it tightly with the hose band.**
- **Do not use the supplied drain hose bent at a 90° angle. (The maximum permissible bend is 45°.)**

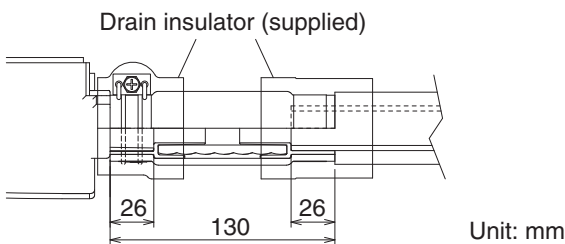
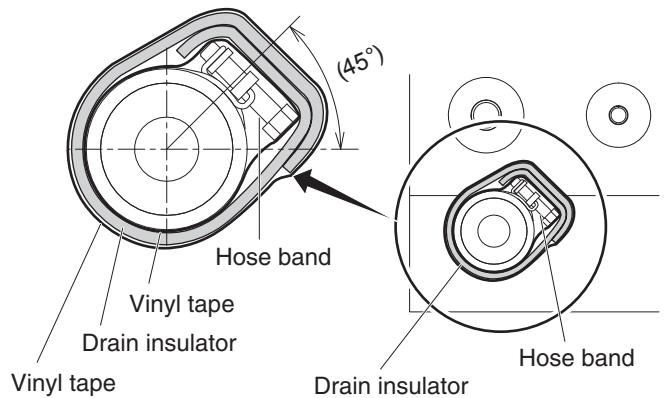
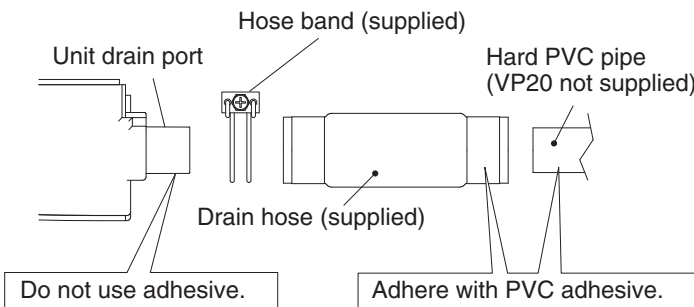

NOTE

Make sure the drain pipe has a downward gradient (1/100 or more) and that there are no water traps.

! CAUTION

- Do not install an air bleeder as this may cause water to spray from the drain pipe outlet.

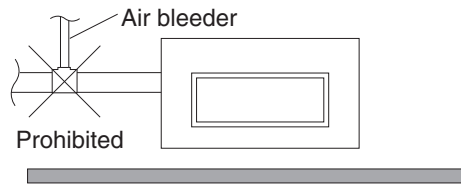

- Make sure that the drain port is not a downward gradient from the joint section (may lead to abnormal noise).
- If it is necessary to increase the height of the drain pipe, the section directly after the connection port can be raised a maximum of 500 mm. Do not raise it any higher than 500 mm, as this could result in water leaks.

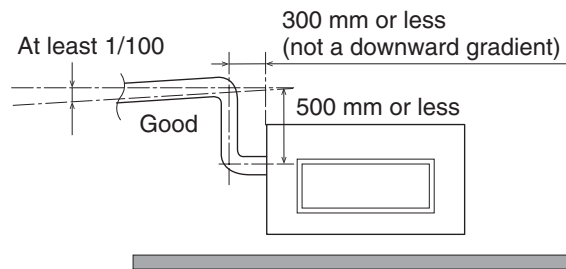

- Do not install the pipe with an upward gradient from the connection port. This will cause the drain water to flow backward and leak when the unit is not operating.

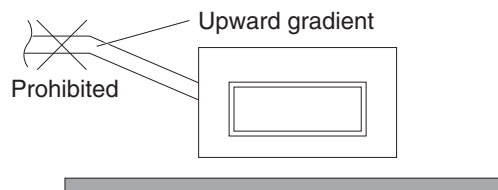

- Do not apply force to the piping on the unit side when connecting the drain pipe. The pipe should not be allowed to hang unsupported from its connection to the unit. Fasten the pipe to a wall, frame, or other support as close to the unit as possible.

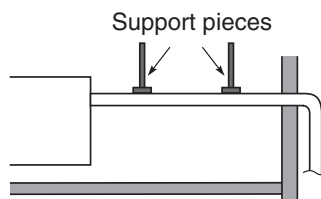

3-7. Checking the Drainage

After wiring and drain piping are completed, use the following procedure to check that the water will drain smoothly. For this, prepare a bucket and wiping cloth to catch and wipe up spilled water.

- (1) Connect power to the power terminal board (L, N terminals) inside the electrical component box.
- (2) Remove the eyelet cap and slowly pour about 500 cc of water through the opening into the drain pan to check drainage.
- (3) Short the check pin (CHK) on the indoor unit control PCB and operate the drain pump. Check the water flow through the transparent upper drain port and see if there is any leakage.

CAUTION

Be careful since the fan will start when you short the pin on the indoor unit control PCB.

- (4) When the drainage check is complete, open the check pin (CHK) and remount the insulator and the cap onto the drain inspection port.

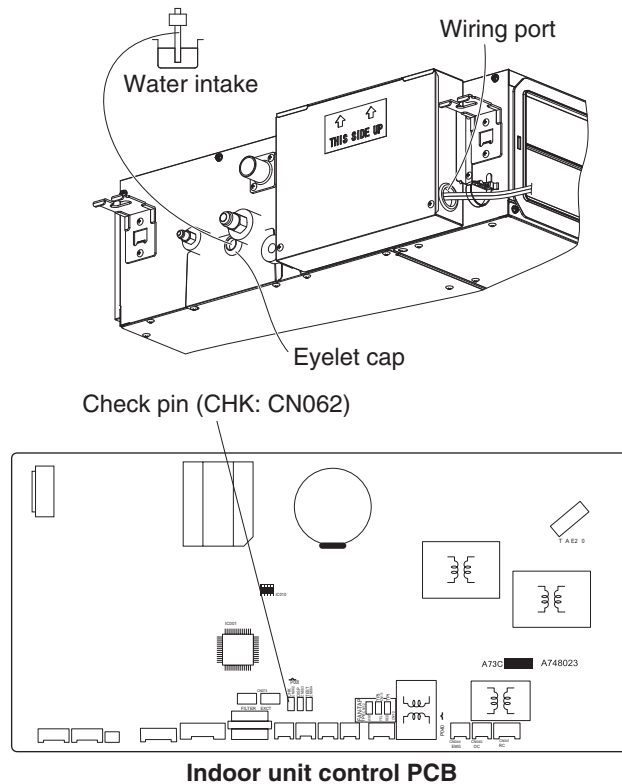

4. ELECTRICAL WIRING

4-1. General Precautions on Wiring

- (1) Before wiring, confirm the rated voltage of the unit as shown on its nameplate, then carry out the wiring closely following the wiring diagram under Section 4-3.



WARNING

- (2) This equipment is strongly recommended to be installed with Earth Leakage Circuit Breaker (ELCB) or Residual Current Device (RCD). Otherwise, it may cause electrical shock and fire in case of equipment breakdown or insulation breakdown.
The ELCB must be incorporated in the fixed wiring in accordance with the wiring regulations. The ELCB must be an approved circuit capacity, having a contact separation in all poles.
The ELCB or RCD suitable for use with inverters, resistant to high frequency noise, is most suitable. The ELCB's or RCD's intended for protection to include high frequency currents are unnecessary and should be avoided, as potentially causing nuisance tripping, in this application.
- (3) To prevent possible hazards from insulation failure, the unit must be grounded.
- (4) Each wiring connection must be done in accordance with the wiring system diagram. Wrong wiring may cause the unit to misoperate or become damaged.
- (5) Do not allow wiring to touch the refrigerant tubing, compressor, or any moving parts of the fan.
- (6) Unauthorized changes in the internal wiring can be very dangerous. The manufacturer will accept no responsibility for any damage or misoperation that occurs as a result of such unauthorized changes.
- (7) Regulations on wire diameters differ from locality to locality. For field wiring rules, please refer to your LOCAL ELECTRICAL CODES before beginning.
You must ensure that installation complies with all relevant rules and regulations.
- (8) To prevent malfunction of the air conditioner caused by electrical noise, care must be taken when wiring as follows:
 - The remote control wiring and the inter-unit control wiring should be wired apart from the inter-unit power wiring.
 - Use shielded wires for inter-unit control wiring between units and ground the shield on both sides.



CAUTION

Check local electrical codes and regulations before wiring. Also, check any specified instruction or limitations.

4-2. Wire Length and Wire Diameter for Power Supply System

Indoor unit

Type	(B) Power supply cable	Time delay fuse or circuit capacity
	Min. 2.5 mm ² *1	
M1	Max. 130 m *2	15 A

Control wiring

(C) Inter-unit (between outdoor and indoor units) control wiring	(D) Remote control wiring	(E) Remote control wiring for group control
Min. 0.75 mm ² Use shielded wiring*3	Min. 0.75 mm ²	Min. 0.75 mm ²
Max. 1,000 m	Max. 500 m	Max. 200 m (Total)

NOTE

*1 Maximum applicable wire for terminal board of indoor unit : 4 mm²

*2 Maximum length shows a 2% voltage drop.

*3 With ring-type wire terminal

4-3. Wiring System Diagrams

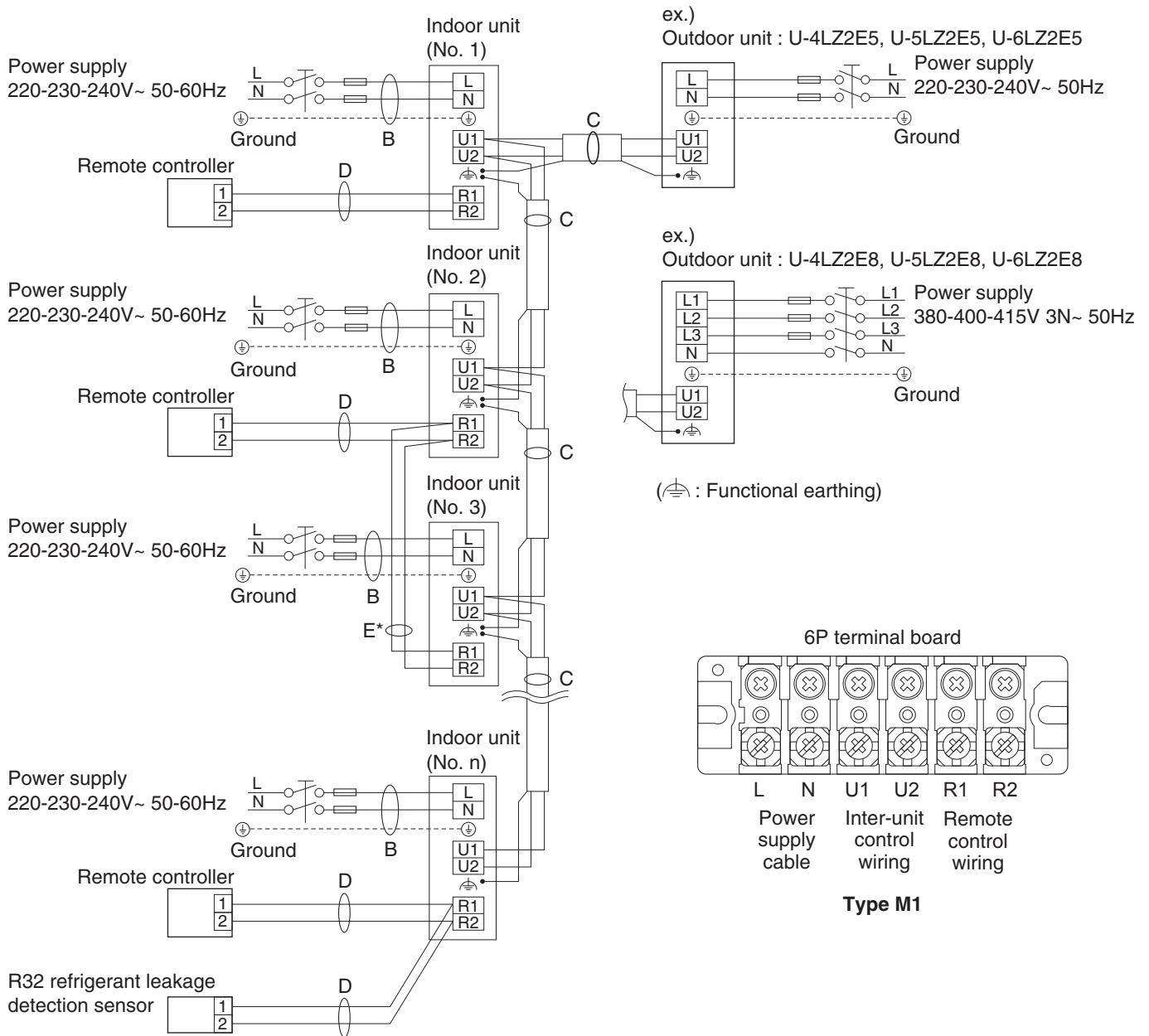

NOTE

- (1) See Section 4-2 for the explanation of “B”, “C”, “D” and “E” under Section 4-3.
 - (2) The basic connection diagram of the indoor unit shows the terminal boards, so the terminal boards in your equipment may differ from the diagram.
 - (3) Refrigerant Circuit address should be set before turning the power on.
 - (4) Regarding Refrigerant Circuit address setting, refer to the installation instructions supplied with the remote controller (Optional). Auto address setting can be executed by remote controller automatically.
 - (5) In the case of connecting R32 refrigerant leakage detection sensor :
 - Be sure to make wirings through the ceiling or the walls so that the wires of R32 refrigerant leakage detection sensor cannot be visible from inside the room.
 - A single R32 refrigerant leakage detection sensor cannot be connected to multiple indoor units.
- * Group connection “E” with a remote controller is not possible. Be sure to connect a remote controller to each indoor unit.

⚠ CAUTION

- (1) When linking the outdoor units in a network, disconnect the terminal extended from the short plug from all outdoor units except any one of the outdoor units.
 (When shipping: In shorted condition.)
 For a system without link (no wiring connection between outdoor units), do not remove the short plug.

- (2) Do not install the inter-unit control wiring in a way that forms a loop.

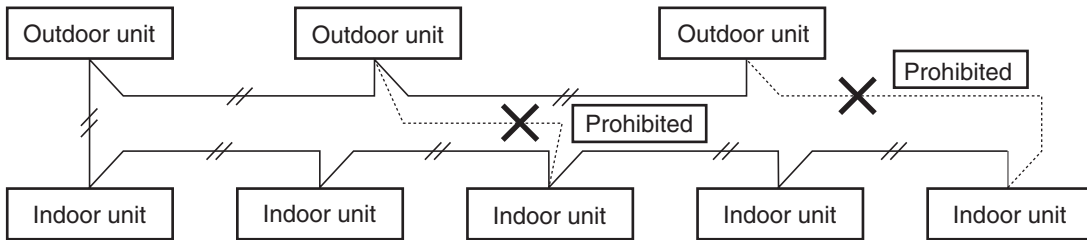

- (3) Do not install inter-unit control wiring such as star branch wiring. Star branch wiring causes mis-address setting.

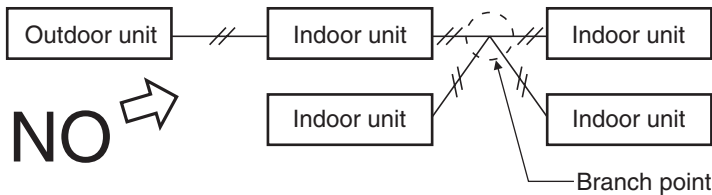

- (4) If branching the inter-unit control wiring, the number of branch points should be 16 or fewer.

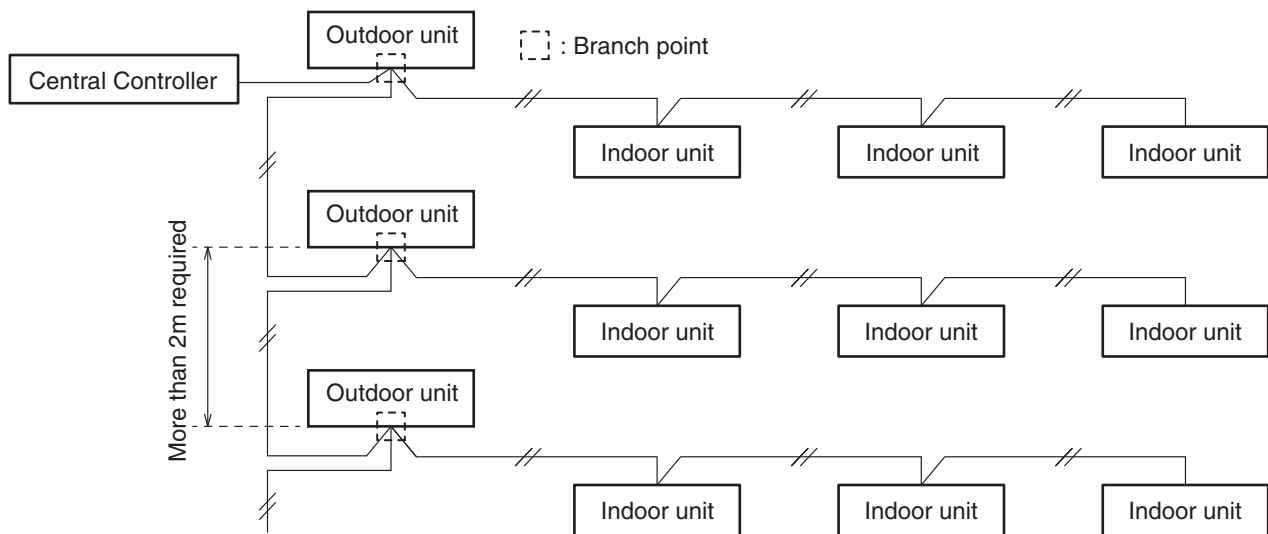

- (5) Use shielded wires for inter-unit control wiring (C) and ground the shield on both sides, otherwise misoperation from noise may occur. Connect wiring as shown in Section 4-3.

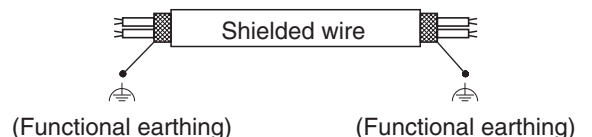

- (6) Use the standard power supply cables for Europe (such as H05RN-F or H07RN-F which conform to CENELEC (HAR) rating specifications) or use the cables based on IEC standard. (60245 IEC57, 60245 IEC66)

! WARNING

Loose wiring may cause the terminal to overheat or result in unit malfunction. A fire hazard may also occur. Therefore, ensure that all wiring is tightly connected.

When connecting each power wire to the terminal, follow the instructions on “How to connect wiring to the terminal” and fasten the wire securely with the terminal screw.

How to connect wiring to the terminal

■ For stranded wiring

- (1) Cut the wire end with cutting pliers, then strip the insulation to expose the stranded wiring about 10 mm and tightly twist the wire ends.
- (2) Using a Phillips head screwdriver, remove the terminal screw(s) on the terminal board.
- (3) Using a ring connector fastener or pliers, securely clamp each stripped wire end with a ring pressure terminal.
- (4) Place the ring pressure terminal, and replace and tighten the removed terminal screw using a screwdriver.

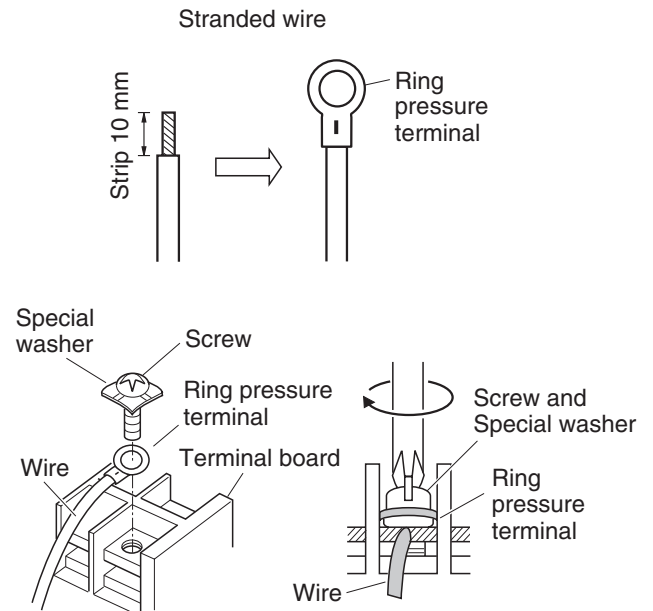

■ Examples of shield wires

- (1) Remove cable coat not to scratch braided shield.
- (2) Unbraid the braided shield carefully and twist the unbraided shield wires tightly together. Insulate the shield wires by covering them with an insulation tube or wrapping insulating tape around them.
- (3) Remove coat of signal wire.
- (4) Attach ring pressure terminals to the signal wires and the shield wires insulated in Step (2).

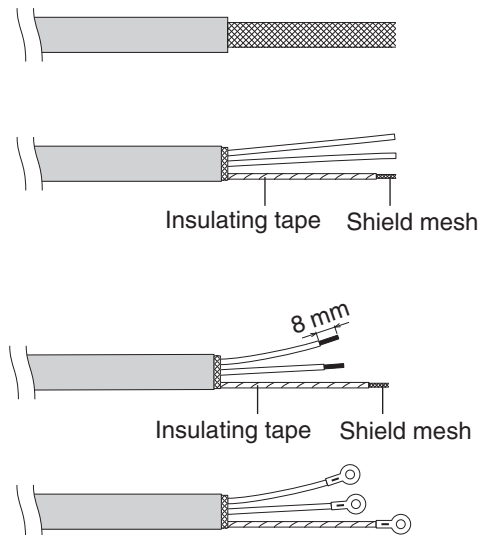

■ Wiring samples

Clamper inside the box for remote control wiring and inter-unit control wiring

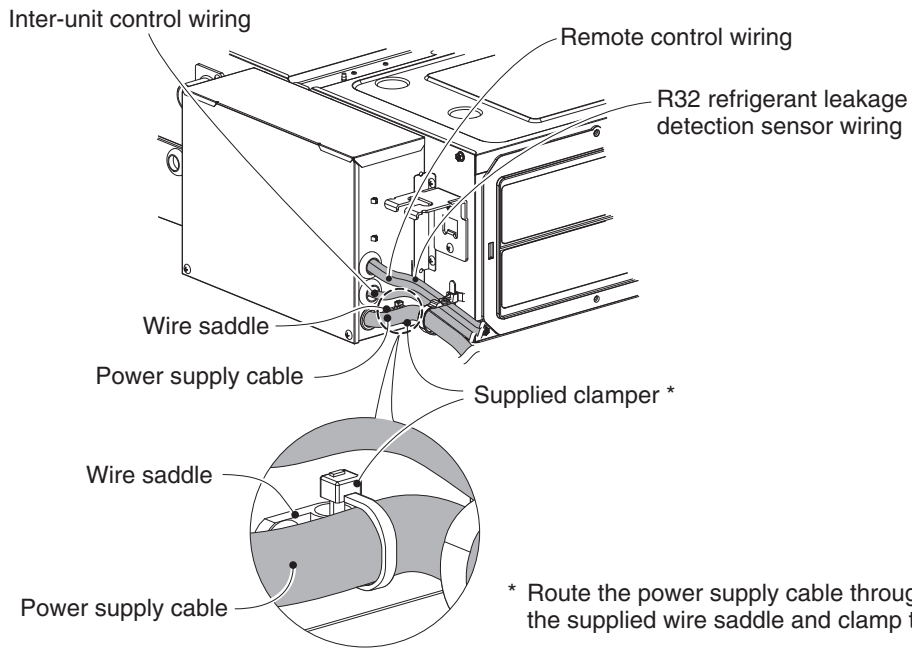
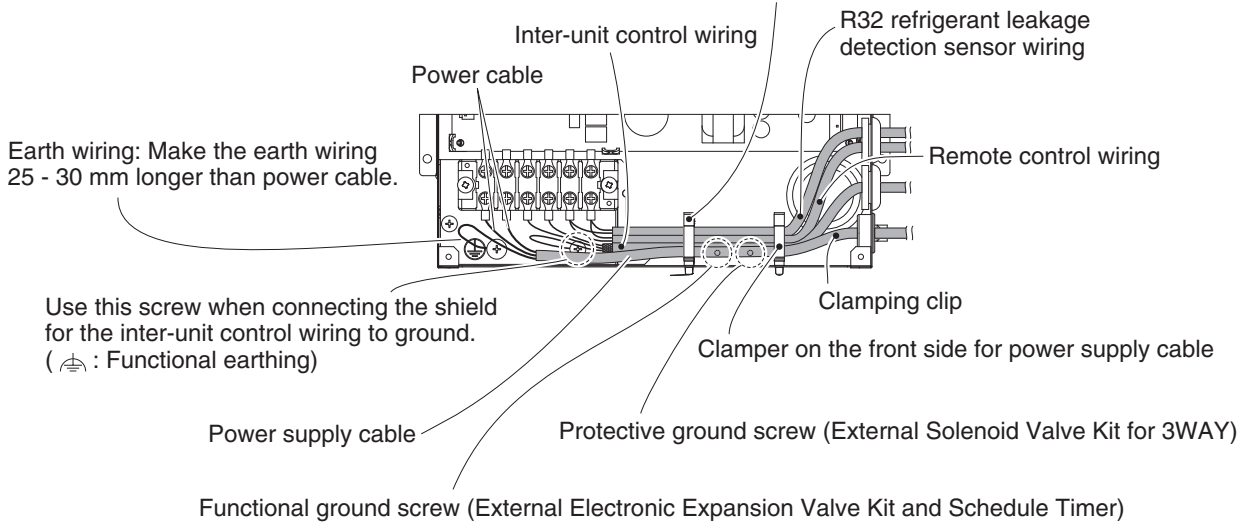

5. HOW TO PROCESS TUBING

Must ensure mechanical connections be accessible for maintenance purposes.

5-1. Connecting the Refrigerant Tubing

Use of the Flaring Method

Many of conventional split system air conditioners employ the flaring method to connect refrigerant tubes that run between indoor and outdoor units. In this method, the copper tubes are flared at each end and connected with flare nuts.

Flaring Procedure with a Flare Tool

- (1) Cut the copper tube to the required length with a tube cutter. It is recommended to cut approx. 30 – 50 cm longer than the tubing length you estimate.
- (2) Remove burrs at each end of the copper tubing with a tube reamer or a similar tool. This process is important and should be done carefully to make a good flare. Be sure to keep any contaminants (moisture, dirt, metal filings, etc.) from entering the tubing.

NOTE

When reaming, hold the tube end downward and be sure that no copper scraps fall into the tube.

- (3) Remove the flare nut from the unit and be sure to mount it on the copper tube.
- (4) Make a flare at the end of the copper tube with a flare tool.

NOTE

When flared joints are reused, the flare part shall be re-fabricated. A good flare should have the following characteristics:

- inside surface is glossy and smooth
- edge is smooth
- tapered sides are of uniform length

Caution Before Connecting Tubes Tightly

- (1) Apply a sealing cap or water-proof tape to prevent dust or water from entering the tubes before they are used.
 - (2) Be sure to apply refrigerant lubricant (ether oil) to the inside of the flare nut before making piping connections. This is effective for reducing gas leaks.
 - (3) For proper connection, align the union tube and flare tube straight with each other, then screw on the flare nut lightly at first to obtain a smooth match.
- Adjust the shape of the liquid tube using a tube bender at the installation site and connect it to the liquid tubing side valve using a flare.

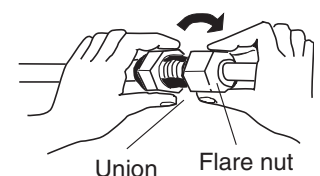
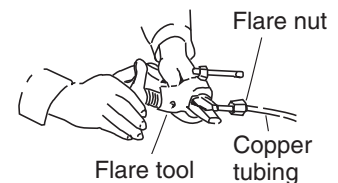
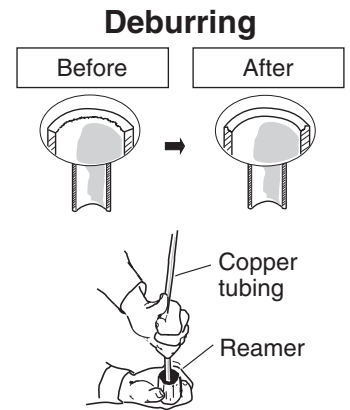

5-2. Connecting Tubing Between Indoor and Outdoor Units

NOTE

When connecting to the mini VRF 8HP, 10HP (outdoor units type LE1 only), select the main tube by using the following values. For details, refer to the installation instructions of the outdoor unit.

Indoor unit	15	22	28	36	45	56
Type M1	0.098					

- (1) Tightly connect the indoor-side refrigerant tubing extended from the wall with the outdoor-side tubing.

Indoor Unit Tubing Connection

Unit : mm

Indoor unit type	15	22	28	36	45	56
Gas tube	ø12.7					
Liquid tube	ø6.35					

- (2) To fasten the flare nuts, apply specified torque.

- When removing the flare nuts from the tubing connections, or when tightening them after connecting the tubing, be sure to use two spanners. When tightening the flare nuts, use a torque wrench. If the flare nuts are over-tightened, the flare may be damaged, which could result in refrigerant leakage and cause injury or asphyxiation to room occupants.

- For the flare nuts at tubing connections, be sure to use the flare nuts that were supplied with the unit, or else flare nuts for R410A, R32 (type 2). The refrigerant tubing that is used must be of the correct wall thickness as shown in the table at right.

Because the pressure is approximately 1.6 times higher than conventional refrigerant R22 pressure, the use of ordinary flare nuts (type 1) or thin-walled tubes may result in tube rupture, injury, or asphyxiation caused by refrigerant leakage.

Tube diameter	Tightening torque (approximate)	Tube thickness
ø6.35 (1/4")	14 – 18 N · m {140 – 180 kgf · cm}	0.8 mm
ø9.52 (3/8")	34 – 42 N · m {340 – 420 kgf · cm}	0.8 mm
ø12.7 (1/2")	49 – 61 N · m {490 – 610 kgf · cm}	0.8 mm
ø15.88 (5/8")	68 – 82 N · m {680 – 820 kgf · cm}	1.0 mm

- In order to prevent damage to the flare caused by over-tightening of the flare nuts, use the table on the right as a guide when tightening.
- When tightening the flare nut on the liquid tube, use an adjustable wrench with a nominal handle length of 200 mm.

5-3. Insulating the Refrigerant Tubing

Tubing Insulation

Must ensure that pipe-work shall be protected from physical damage.

- Thermal insulation must be applied to all units tubing, including distribution joint (field supply).

* For gas tubing, the insulation material must be heat resistant to 120°C or above. For other tubing, it must be heat resistant to 80°C or above.

Insulation material thickness must be 10 mm or greater.

If the conditions inside the ceiling exceed DB 30°C and RH 70%, increase the thickness of the gas tubing insulation material by 1 step.

Two tubes arranged together

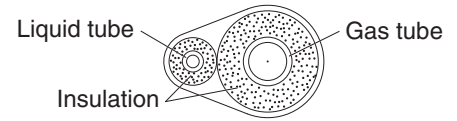

⚠ CAUTION

If the exterior of the outdoor unit valves has been finished with a square duct covering, make sure you allow sufficient space to access the valves and to allow the panels to be attached and removed.

Additional Precautions For R32 Models

⚠ Ensure to do the re-flaring of pipes before connecting to units to avoid leaking.

To prevent the ingress of moisture into the joint which could have the potential to freeze and then cause leakage, the joint must be sealed with suitable silicone and insulation material. The joint should be sealed on both liquid and gas side.

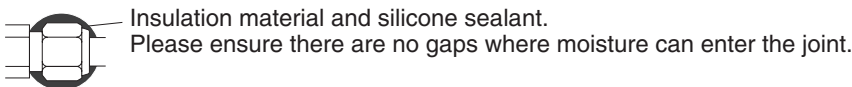

Silicone Sealant must be neutral cure and ammonia free. Use of silicone containing ammonia can lead to stress corrosion on the joint and cause leakage.

Insulation of the flare nuts

Attach the flare insulator (supplied) just like wrapping around the flare nut (supplied). Match the both slits of flare insulators for gas and liquid tubes facing upward. Tightly attach the end of the flare insulators to the tube cradle without any space. Then clamp the flare insulator with the clampers about 20 mm away from both ends.

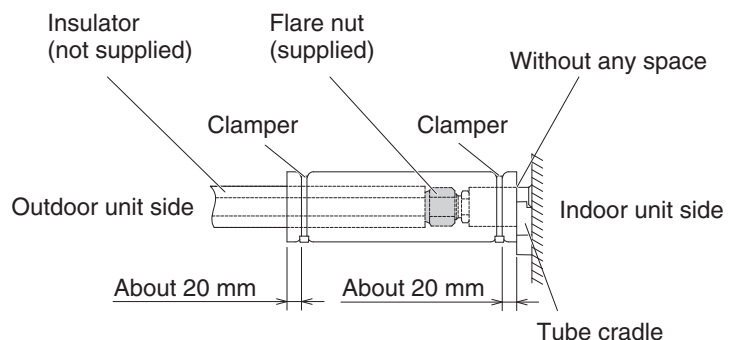
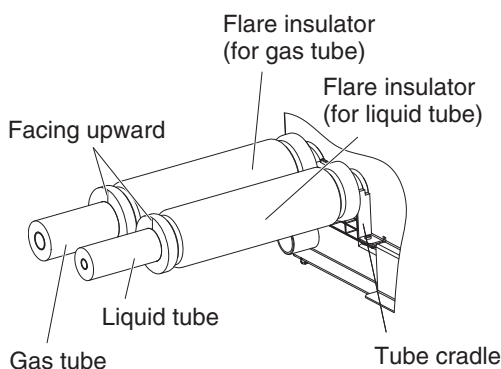

NOTE

Tighten the clampers to prevent any condensation that may occur as the copper tubing is exposed.

Insulation material

The material used for insulation must have good insulation characteristics, be easy to use, be age resistant, and must not easily absorb moisture.

NOTE

If noise bothers you from the area between indoor and outdoor units' connection pipes, it is effective to wind the soundproofing materials (field supply) to reduce noise.



CAUTION

After a tube has been insulated, never try to bend it into a narrow curve because it can cause the tube to break or crack.

Never grasp the drain or refrigerant connecting outlets when moving the unit.

5-4. Taping the Tubes

- (1) At this time, the refrigerant tubes (and electrical wiring if local codes permit) should be taped together with armoring tape in 1 bundle. To prevent condensation from overflowing the drain pan, keep the drain hose separate from the refrigerant tubing.
- (2) Wrap the armoring tape from the bottom of the outdoor unit to the top of the tubing where it enters the wall. As you wrap the tubing, overlap half of each previous tape turn.
- (3) Clamp the tubing bundle to the wall, using 1 clamp approx. each meter.

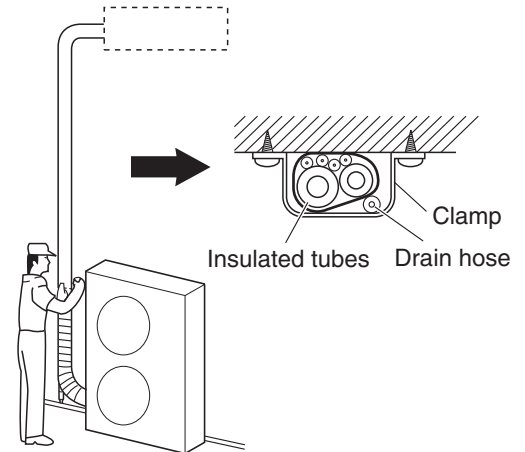

NOTE

Do not wind the armoring tape too tightly since this will decrease the heat insulation effect. Also ensure that the condensation drain hose splits away from the bundle and drips clear of the unit and the tubing.

5-5. Finishing the Installation

After finishing insulating and taping over the tubing, use sealing putty to seal off the hole in the wall to prevent rain and draft from entering.

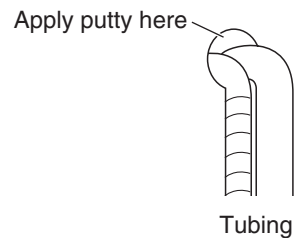

6. HOW TO INSTALL THE TIMER REMOTE CONTROLLER OR HIGH-SPEC WIRED REMOTE CONTROLLER (OPTIONAL PART)

NOTE

Refer to the Installation Instructions attached to the optional Timer Remote Controller or optional High-spec Wired Remote Controller.

7. HOW TO INSTALL WIRELESS REMOTE CONTROLLER

NOTE

Refer to the Installation Instructions attached to the optional Wireless Remote Controller.

8. CHECKLIST AFTER INSTALLATION WORK

Work List	No.	Content	Check <input checked="" type="checkbox"/>	Possibility of Failure & Checkpoint	
Installation	1	Are the indoor units installed following the content of Section "2. SELECTING THE INSTALLATION SITE"?	<input type="checkbox"/>	There is a possibility of light injure or loss of property.	
Tubing & Wiring	2	In the case of multiple installation: Is there a wrong tubing connection with another system?	<input type="checkbox"/>	The unit is inoperated or the refrigerant flows into the inoperative unit and the leakage is expected. Check if there is a wrong tubing or wiring connection with another system.	
	3	In the case of multiple installation: Is there a wrong wiring connection with another system?	<input type="checkbox"/>		
	4	Is the earth leakage circuit breaker (all-pole switching function provided) installed?	<input type="checkbox"/>	Power failure or short circuit may cause electric shock or fire. Check installation work and ground wire work.	
	5	Is there any wrong installation of optional parts or wrong wiring?	<input type="checkbox"/>		
	6	Was the ground wire work performed?	<input type="checkbox"/>		
	7	Are there any wrong power supply wiring, wrong connection wire, wrong signal wire or loose screw?	<input type="checkbox"/>		
	8	Is the thickness of wire in accordance with rule?	<input type="checkbox"/>		
	9	Is the power-supply voltage equal to the nameplate of the unit?	<input type="checkbox"/>		
	10	Was the check of the airtight test, flared tube fitting and gas leakage on the welded portion performed?	<input type="checkbox"/>		If the gas leakage occurs, the unit quality not only becomes inferior but affects environment. Repair it as quickly as possible.
	Drain Check	11	Has the adhesive been applied to the drain connecting portion (resin portion) of the indoor unit?		<input type="checkbox"/>
12		Is there water leakage?	<input type="checkbox"/>	Since there is a possibility of water drain, repair the drain pipe if the drain failure or water drain occurs.	
13		Indoor unit drain pipe has a downward gradient (1/100 or more) by rule. Is the drain water flowing smoothly?	<input type="checkbox"/>		
Heat Insulation	14	Was the heat insulation work at a suitable location including the flared tube fitting (refrigerant tube & drain pipe) performed properly?	<input type="checkbox"/>	The quality of unit not only becomes inferior but there is a possibility of the water drain. So, perform the heat insulation work properly.	
Test Run	15	Did the abnormal sound occur?	<input type="checkbox"/>	Check if there is a fan contact or distortion of the indoor unit.	
	16	Did the cool and warm airflow discharge from the indoor unit?	<input type="checkbox"/>	Check if the unit does not operate or there is a wrong tubing or wiring connection with another system.	

9. EXTERNAL STATIC PRESSURE SETTING

Choose one of the following methods from “a”, “b”, “c” as shown in the flow chart (within the dotted lines) and then make the setting accordingly.

- a. No setting modification:
When using as it is factory preset at shipment.
(If resetting after external static pressure setting once, it might be different from factory preset.)
- b. Manual setting (set with the indoor unit control PCB):
This is static pressure setting excepting factory preset at shipment. Switching method with the short-circuit connector.
- c. Manual setting (set with the wired remote controller):
Static pressure setting excepting factory preset at shipment.

Flow of External Static Pressure

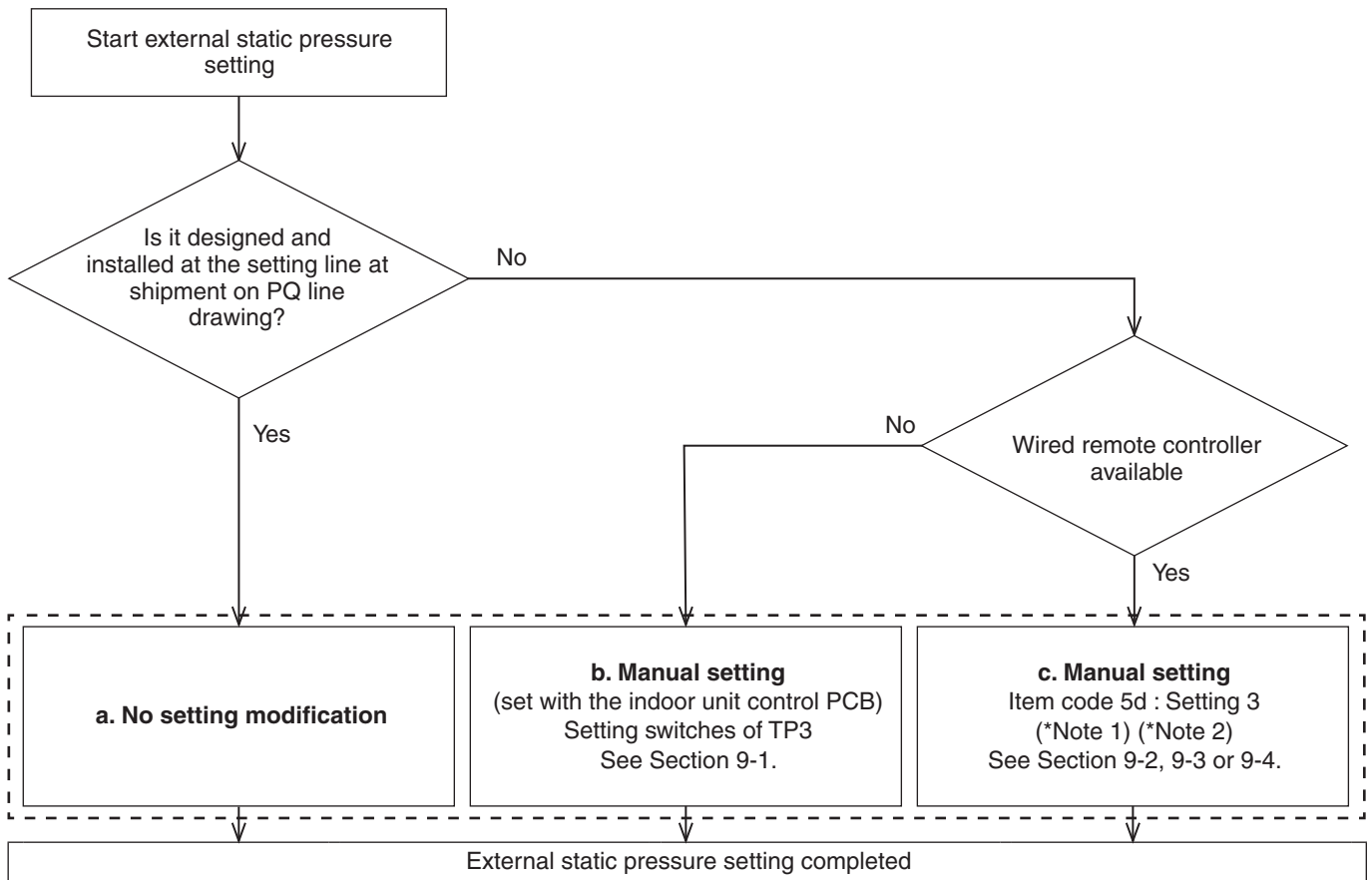

- (1) See Table 9-2, 9-3, 9-4 and Fig. 9-2 for details on the relationship between the value of item code “5d” and the external static pressure.
- (2) When set in group control (connecting multiple indoor units with one wired remote controller), set each indoor unit to item code “5d”.
When amending the setting after selecting [b. Manual setting] (due to airflow path changes, etc.), it is necessary to cancel [b. Manual setting] (switching OFF positions). When [b. Manual setting] has not been cancelled, [c. Manual setting] will be activated if selected, but [b. Manual setting] takes precedence when the power is switched back on after power outages, etc.

CAUTION

- Make sure the external static pressure is in a range of specifications. Then proceed the external static pressure setting. Improper settings can cause noise, a shortage of airflow volume and water leakage. See Fig. 9-2 for the external static pressure setting range.
- Be sure to set the [External Static Pressure Setting] once again after amending the airflow path for the duct or air outlet after setting the external static pressure.

9-1. How to Set on Indoor Unit Control PCB

1. Turn off the power breaker to halt the supply of electricity to the indoor unit control PCB.
2. Open the electrical component box cover, then check the indoor unit control PCB. When using with high static pressure mode, set the indoor unit control PCB as shown in Fig. 9-1.
3. Connect the short circuit connector to the short circuit pin TP3 (2P: Yellow) of the indoor unit control PCB.
 - In the case of wired remote controller setting, do not use the short circuit connector.

Table 9-1 External static pressure

Type	15	22	28	36	45	56
Standard (Pa) (shipment)	10		15		15	
High static pressure (Pa)	30		30		40	

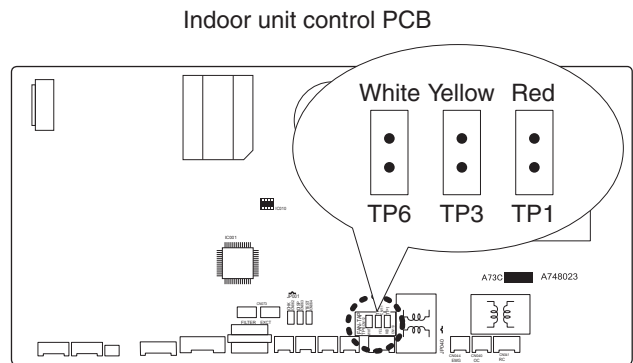



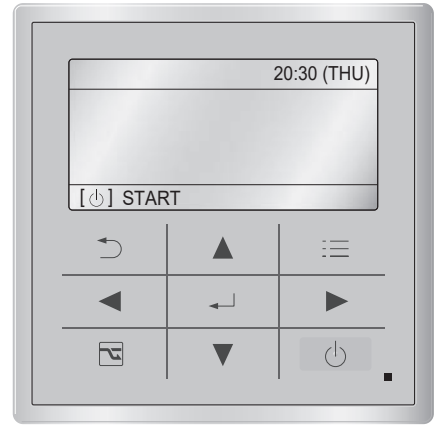
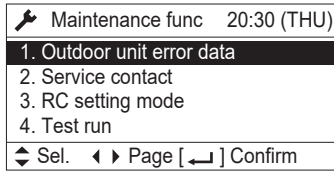







Fig. 9-1



9-2. Operating the High-spec Wired Remote Controller (CZ-RTC5B)

How to set the external static pressure







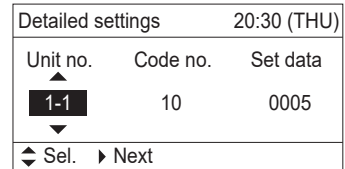
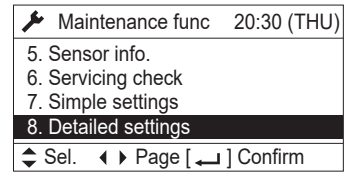

- Keep pressing the ,  and  buttons simultaneously for 4 or more seconds. The “Maintenance func” screen appears on the LCD display.



- Press the  or  button to see each menu. If you wish to see the next screen instantly, press the  or  button. Select “8. Detailed settings” on the LCD display and press the  button.

The “Detailed settings” screen appears on the LCD display. Select the “Unit no.” by pressing the  or  button for changes.



- Select the “Code no.” by pressing the  or  button. Change the “Code no.” to “5D” by pressing the  or  button (or keeping it pressed).
- Select the “Set data” by pressing the  or  button. Select the “Set data” of either “0000” or “0003” according to the desired external static pressure setting by pressing the  or  button. Then press the  button.

(See Table 9-2.)

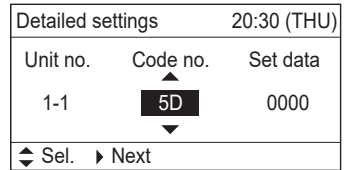



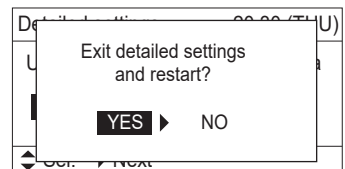

Table 9-2 Setting the external static pressure











Indoor unit type						Item code
15	22	28	36	45	56	
External static pressure of the rated airflow volume (Pa)						5D
10	15	15				0000
30	30	40				0003

- Select the “Unit no.” by pressing the  or  button and press the  button. The “Exit detailed settings and restart?” (Detailed setting-end) screen appears on the LCD display. Select “YES” and press the  button. When the setting is completed, perform the test run for the external static pressure setting.



9-3. Operating the Timer Remote Controller (CZ-RTC4)

How to set the external static pressure

1. Press and hold down the ,  and  buttons simultaneously for 4 or more seconds. (**SETTING**, the unit no., item code and detailed data will blink on the LCD display.)
2. The indoor unit numbers in the group control will be sequentially displayed whenever the Unit Select button is pressed . Only the fan motor for the selected indoor unit will operate during this time.
3. Specify the “5d” item code by pressing the  /  buttons for the temperature setting buttons and confirm the values. (“00 00” set at shipment)
4. Press the  /  buttons for the time to amend the values for the set data. See Table 9-3 and Fig. 9-2 and select a value “00 00” and “00 03”.
5. Press the  button. The display will stop blinking and remain illuminated.
6. Press the  button. The fan motor will stop operating and the LCD display will return to the normal stop mode.

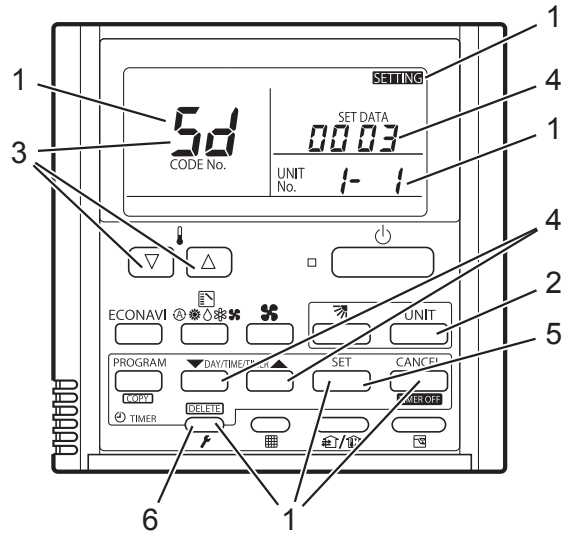





Table 9-3 Setting the external static pressure

Indoor unit type						Item code
15	22	28	36	45	56	5d
External static pressure of the rated airflow volume (Pa)						
10	15	15				00 00
30	30	40				00 03



9-4. Operating the Wired Remote Controller (CZ-RTC6 series)

Stop the system before performing these steps.

How to set the external static pressure

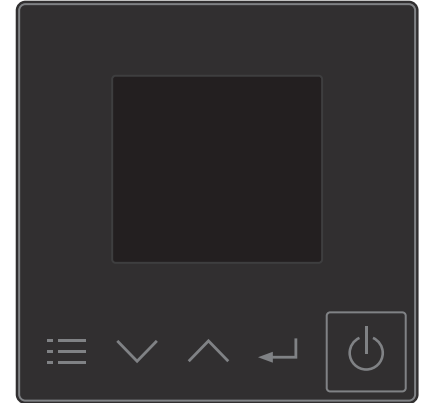
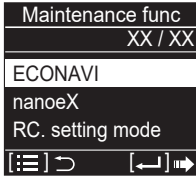



- Keep pressing the ,  and  buttons simultaneously for 4 or more seconds.
The “Main tenance func” screen appears on the LCD display.

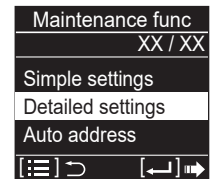







- Press the  or  button to see each menu.
Select “Detailed settings” on the LCD display and press the  button.

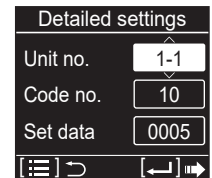



The “Detailed settings” screen appears on the LCD display.

- Select the “Unit no.” by pressing the  or  button.
After selecting “Unit no.”, press the  button and proceed to Step 4.
If the  button is pressed, proceed to Step 6.

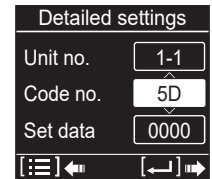

- Select the “Code no.” by pressing the  or  button.
Change the “Code no.” to “5D” by pressing the  or  button (or keeping it pressed).
After selecting “Code no.”, press the  button and proceed to Step 5.



- Select the “Set data” of either “0000” or “0003” according to the desired external static pressure setting by pressing the  or  button.
(See Table 9-4.)

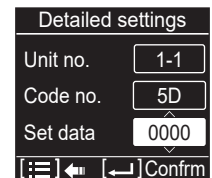





After selecting “Set data”, press the  button. (If setting continuously, follow the procedures from Step 3.)

Table 9-4 Setting the external static pressure

Indoor unit type						Item code
15	22	28	36	45	56	5D
External static pressure of the rated airflow volume (Pa)						
10	15	15				0000
30	30	40				0003

- If the  button is pressed under the display Step 3, the following display (Detailed setting-end screen) appears.
Then select “YES” by pressing the  or  button and press the  button.



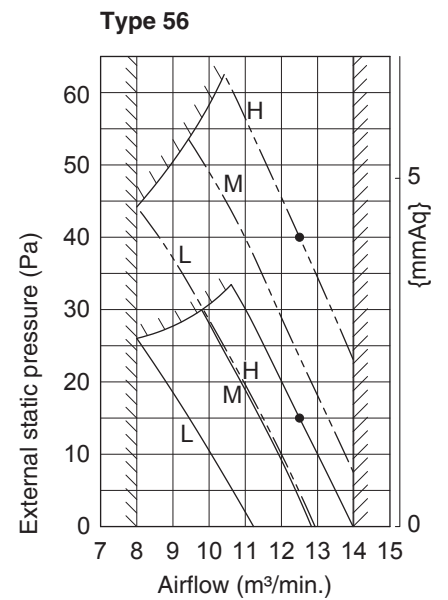
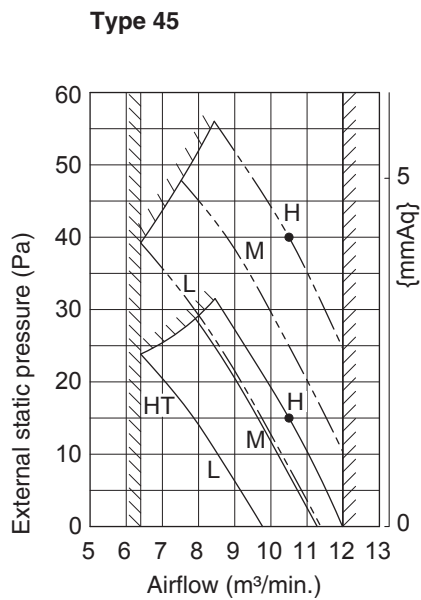
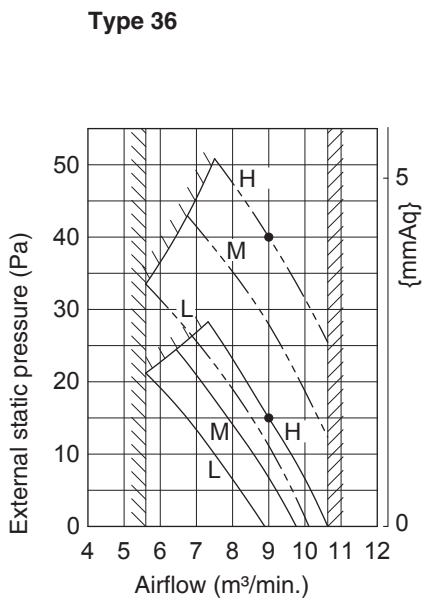
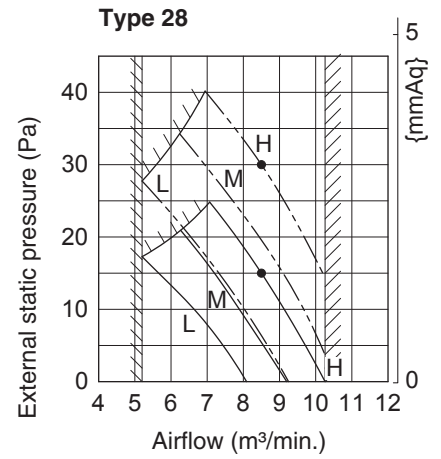
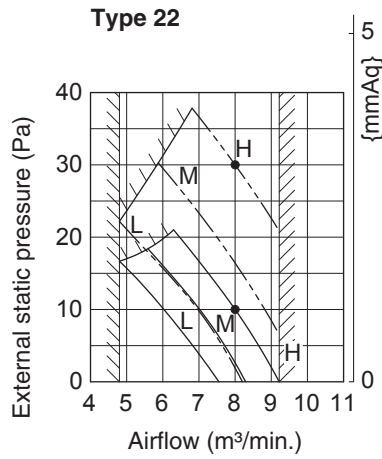
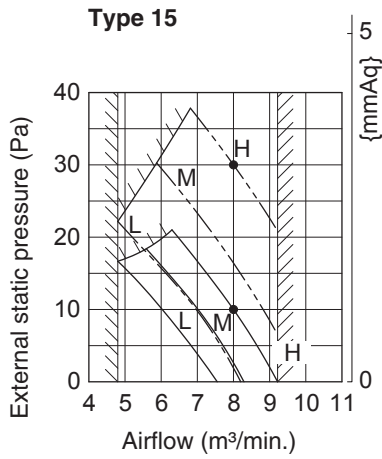
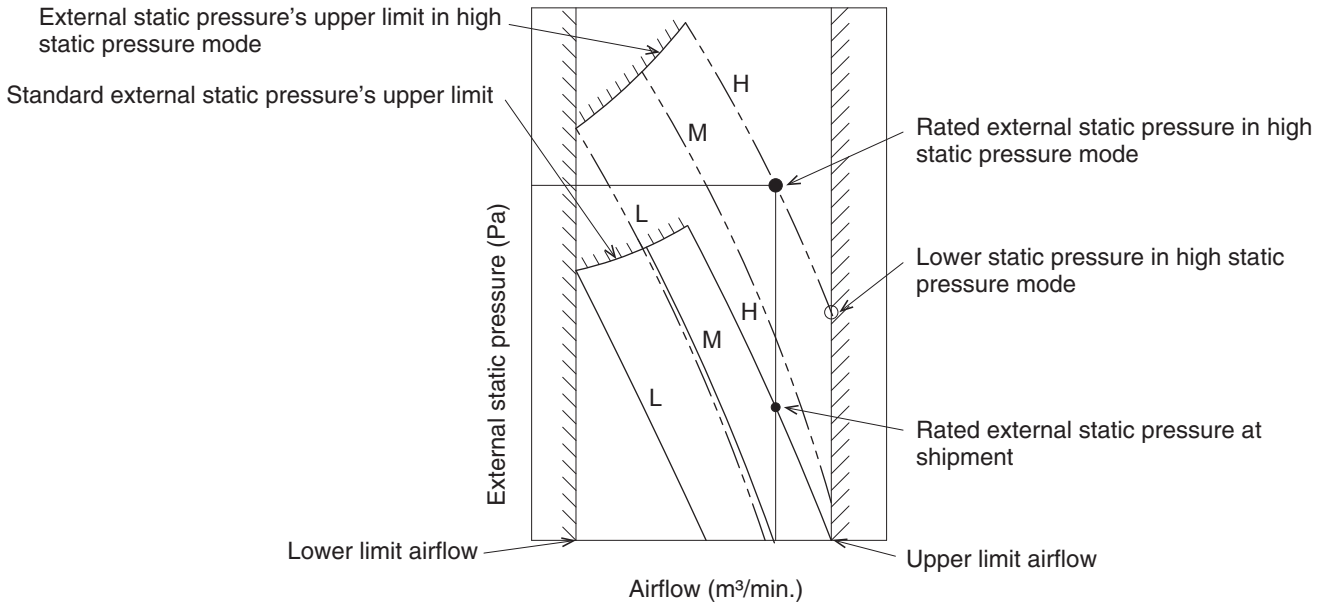

Fig. 9-2

10. APPENDIX

■ Care and Cleaning

⚠ WARNING

- For safety, be sure to turn the air conditioner off and also to disconnect the power before cleaning.
- Do not pour water on the indoor unit to clean it. This will damage the internal components and cause an electric shock hazard.

Air intake and outlet side (Indoor unit)

Clean the air intake and outlet side of the indoor unit with a vacuum cleaner brush, or wipe them with a clean, soft cloth.

If these parts are stained, use a clean cloth moistened with water. When cleaning the air outlet side, be careful not to force the vanes out of place.

⚠ CAUTION

- Never use solvents or harsh chemicals when cleaning the indoor unit. Do not wipe plastic parts using very hot water.
- Some metal edges and the fins are sharp and may cause injury if handled improperly; be especially careful when you clean these parts.
- The internal coil and other components of outdoor unit must be cleaned regularly. Consult your dealer or service center.

Air filter

The air filter collects dust and other particles from the air and should be cleaned at regular intervals or when the filter indication (🧺) on the display of the remote controller (wired type) shows that the filter needs cleaning. If the filter gets blocked, the efficiency of the air conditioner drops greatly.

Type	M1
Period	(Depends on filter specifications)

An air filter is not provided with this air conditioner at the time of shipment. To get clean air and to extend the service life of the air conditioner, an air filter must be installed in the air intake. For installation and cleaning the air filter, consult your dealer or service center.

● After Cleaning

1. After the air filter is cleaned, reinstall it in its original position.
Be sure to reinstall in reverse order.
2. [In the case of Timer Remote Controller]
Press the Filter reset button.
The 🧺 (Filter) indicator on the display goes out.

Timer Remote Controller

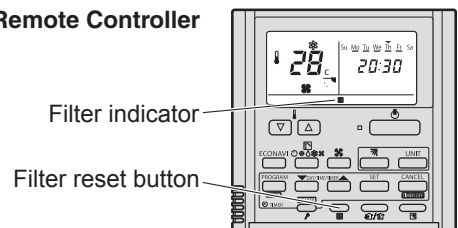

[In the case of High-spec Wired Remote Controller and Wired Remote Controller]

Refer to the Operating Instructions attached to the optional High-spec Wired Remote Controller or optional Wired Remote Controller.

High-spec Wired Remote Controller

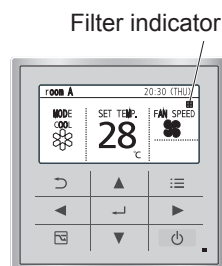

Wired Remote Controller

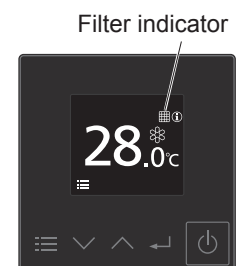

NOTE

The frequency with which the filter should be cleaned depends on the environment in which the unit is used.

Clean the filter frequently for best performance in the area of dusty or oil spots regardless of filter status.

<How to clean the filter>

1. Remove the air filter from the air intake grille.
2. Use a vacuum cleaner to remove light dust. If there is sticky dust on the filter, wash the filter in lukewarm, soapy water, rinse it in clean water, and dry it.

**CAUTION**

- **Certain metal edges and the condenser fins are sharp and may cause injury if handled improperly; special care should be taken when you clean these parts.**
- **Periodically check the outdoor unit to see if the air outlet or air intake is clogged with dirt or soot.**
- **The internal coil and other components must also be cleaned periodically. Consult your dealer or service center.**

Care: After a prolonged idle period

Check the indoor and outdoor unit air intakes and outlets for blockage; if there is a blockage, remove it.

Care: Before a prolonged idle period

- Operate the fan for half a day to dry out the inside.
- Disconnect the power supply and also turn off the circuit breaker.
- Clean the air filter and replace it in its original position.
- Outdoor unit internal components must be checked and cleaned periodically. Contact your local dealer for this service.

■ Troubleshooting

If your air conditioner does not work properly, first check the following points before requesting service. If it still does not work properly, contact your dealer or a service center.



● Indoor unit

Symptom		Cause
Noise	Sound like streaming water during operation or after operation	<ul style="list-style-type: none"> ● Sound of refrigerant liquid flowing inside unit ● Sound of drainage water through drain pipe
	Cracking noise during operation or when operation stops.	Cracking sound due to temperature changes of parts
Odor	Discharged air is smelled during operation.	Indoor odor components, cigarette odor and cosmetic odor accumulated in the air conditioner and its air is discharged. Unit inside is dusty. Consult your dealer.
Dewdrop	Dewdrop gets accumulated near air discharge during operation	Indoor moisture is cooled by cool wind and accumulated by dewdrop.
Fog	Fog occurs during operation in cooling mode. (Places where large amounts of oil mist exist at restaurants.)	<ul style="list-style-type: none"> ● Cleaning is necessary because unit inside (heat exchanger) is dirty. Consult your dealer as technical engineering is required. ● During defrost operation
Fan is rotating for a while even though operation stops.		<ul style="list-style-type: none"> ● Fan rotating makes operation smoothly. ● Fan may sometimes rotate because of drying heat exchanger due to settings.
The indoor unit fan is running and does not stop when ON/OFF operation button on remote controller is pressed.		<ul style="list-style-type: none"> ● The refrigerant may be leaking. If R32 refrigerant leakage detection sensor is connected and the refrigerant leaks, P08 alarm and inspection mark will be displayed on the remote controller and the fan will automatically operate. Please ventilate the room without turning off the earth leakage circuit breaker and contact the service dealer for assistance. ● Are you using gas equipment (propane, butane, methane, etc.) and sprays near R32 refrigerant leakage detection sensor? R32 refrigerant leakage detection sensor could lead to false detection and the fan may start rotating. Please contact the service dealer for assistance.
Dust		Dust accumulation inside indoor unit is discharged.

● Check Before Requiring Services

Symptom	Cause	Remedy
Air conditioner does not run at all although power is turned on.	Power failure or after power failure	Press ON/OFF operation button on remote controller again.
	Operation button is turned off.	<ul style="list-style-type: none"> ● Switch on power if breaker is turned off. ● If breaker has been tripped, consult your dealer without turning it on.
	Fuse blow out.	If blown out, consult your dealer.
Poor cooling or heating performance	Air intake or air discharge port of indoor and outdoor units is clogged with dust or obstacles.	Remove dust or obstruction.
	Fan speed switch is set to "Low".*	Change to "Medium" or "High".*
	Improper temperature settings	See Section "■ Tips for Energy Saving".
	Room is exposed to direct sunlight in cooling mode.	
	Doors and /or windows are open.	
	Air filter is clogged.	See Section "■ Care and Cleaning".
	Too much heat sources in room in cooling mode.	Use minimum heat sources and in a short time.
	Too many people in room in cooling mode.	Reduce temperature settings or change to "Medium" or "High".*

* Fan speed display on the remote controller

High :  (CZ-RTC4, CZ-RTC5B),  (CZ-RTC6*)

Medium :  (CZ-RTC4, CZ-RTC5B),  (CZ-RTC6*)

Low :  (CZ-RTC4, CZ-RTC5B),  (CZ-RTC6*)

- If the P08 alarm and inspection mark are displayed on the remote controller and the fan automatically operates and does not stop even when you press ON/OFF operation button on remote controller, R32 refrigerant leakage detection sensor connected to the indoor unit has detected refrigerant leakage. In such a case, do not turn off the earth leakage circuit breaker, ventilate the room, and contact the service dealer immediately.

If your air conditioner still does not work properly although you checked the points as described above, first stop the operation and turn off the power switch. Then contact your dealer and report the serial number and symptom. Never repair your air conditioner by yourself since it is very dangerous for you to do so. You also report if the inspection mark  and the letters E, F, H, L, P in combination with the numbers appear on the LCD of the remote controller.

■ Tips for Energy Saving

Avoid

- **Do not block the air intake and outlet of the unit. If either is obstructed, the unit will not work well, and may be damaged.**
- Do not let direct sunlight into the room. Use sunshades, blinds or curtains. If the walls and ceiling of the room are warmed by the sun, it will take longer to cool the room.

Do

- Always try to keep the air filter clean. (See Section “■ Care and Cleaning”.) A clogged filter will impair the performance of the unit.
- To prevent conditioned air from escaping, keep windows, doors and any other openings closed.

NOTE

Should the power fail while the unit is running

If the power supply for this unit is temporarily cut off, the unit will automatically resume operation once power is restored using the same settings before the power was interrupted.

Important Information Regarding The Refrigerant Used

NOTE

Refer to the Installation Instructions attached to the outdoor unit.

